

PROPOSED

C2022-1220
ATTACHMENT 3

BYLAW NUMBER 64P2022

BEING A BYLAW OF THE CITY OF CALGARY TO ADOPT THE CHINATOWN AREA REDEVELOPMENT PLAN (C2022-1220)

WHEREAS Section 634 of the *Municipal Government Act*, R.S.A. 2000, c.M-26, as amended, enables a municipal council to pass bylaws adopting area redevelopment plans to control the preservation, rehabilitation, redevelopment, and improvement of lands and improvements within designated areas of the municipality;

AND WHEREAS it is deemed desirable to implement an Area Redevelopment Plan for Chinatown;

AND WHEREAS Council has held a public hearing as required by Section 692 of the *Municipal Government Act*, R.S.A. 2000, c.M-26, as amended:

NOW, THEREFORE, THE COUNCIL OF THE CITY OF CALGARY ENACTS AS FOLLOWS:

1. This Bylaw may be cited as the “Chinatown Area Redevelopment Plan Bylaw”.
2. The Table of Contents and Sections 1 to 6, inclusive, of the document entitled “Chinatown Area Redevelopment Plan” attached to this Bylaw as Schedule “A” are hereby adopted as an area redevelopment plan pursuant to Section 634 of the Municipal Government Act, R.S.A. 2000, c.M-26, as amended.
3. The Chinatown Area Redevelopment Plan, Bylaw 3P86, and all amendments thereto, is hereby repealed.

PROPOSED

BYLAW NUMBER 64P2022

4. This Bylaw comes into force on the date that it is passed.

READ A FIRST TIME ON _____

READ A SECOND TIME ON _____

READ A THIRD TIME ON _____

MAYOR

SIGNED ON _____

CITY CLERK

SIGNED ON _____

PROPOSED

BYLAW NUMBER 64P2022

SCHEDULE "A"



PROPOSED

BYLAW NUMBER 64P2022

Publishing Information

Title

Chinatown Area Redevelopment Plan

Author

The City of Calgary

Status

PROPOSED - 2022, October 14

Additional Copies

The City of Calgary
Records & Information Management (RIM)
Calgary Building Services
P.O. Box 2100, Station M, Mail Code: 8115
Calgary, AB T2P 2M5

Phone

311 or if outside Calgary, 403-268-2489

Fax

403-268-4615

calgary.ca

19-0000376-ADV-10430

Land acknowledgment

In the Blackfoot language, Calgary is Moh'kin'stis; in Îyâxe Nakoda, it's Wiçispa Oyade; in Tsuut'ina, Gu'tsi'tsi and in Métis, it's Otoskwunee. For each of these Indigenous languages, the words translate to 'elbow,' representing the confluence of the Bow and Elbow Rivers. The confluence has been a trading hub for Indigenous Peoples for more than a thousand years. It's the site where they celebrated natural abundance, ceremony, culture and partnerships. This is where Calgary's story begins.

In support of seeking Truth and Reconciliation, this Plan acknowledges the traditional territories of the people of the Treaty 7 region in Southern Alberta. The Nations of the Treaty 7 region are the Siksika (Seeg-see-gah), Piikani (Pee-gah-nee), and Kainai (G-ai-nah) First Nations. Together they form the Siksikaitsitapi (Seeg-see-gate-see-ta- pee), also known as the Blackfoot Confederacy. The Chiniki (Chin-ick-ee), Bearspaw and Wesley First Nations, form the Iethka Nakoda Wicistabi (Yith-ka Na-ko-da We-chi-staw-bee) Stoney Nakoda First Nations and the Tsuut'ina (Soot-tenna) First Nation. The city of Calgary is also homeland to the historic Northwest Métis and to the Métis Nation of Alberta, Region 3. We acknowledge all Indigenous people who make Calgary home. This Plan honours their long history and deep connections to this land.

We also reflect on the impact of colonization. Calgary is based on wealth that was generated through the exploitation of Indigenous Peoples and their land, and has benefited from colonial policy. We recognize the ongoing impact of colonization and systemic racism that continues to affect Indigenous Peoples in this country. With this acknowledgment comes a corresponding moral obligation to seek reconciliation with Indigenous Peoples, which includes recognizing and understanding the truth about the past and taking action to achieve equity in the future.

Our commitment to equality, inclusion and accessibility

Chinatown is a place for all residents of and visitors to Calgary. Over the years, marginalized groups have identified the need for The City to take a more inclusive approach to service delivery. Social movements highlight the need for more sincere and effective measures to achieve equality for all. The City of Calgary strives to do better. This Plan provides direction for further study, accountability and investment to work to correct issues resulting from systemic racism.

To start, we encourage anyone doing work in Chinatown to commit to the following:

- Be intentional about involving diverse communities as part of your decision-making processes. Demonstrate that you recognize Chinatown as an equitable and inclusive place for everyone. Reference The City of Calgary's Access Design Standards to understand the full spectrum of disabilities that need to be accounted for.
- Empower public participation when shaping future policy, projects and initiatives, in line with The City's Engage policy.
- Include community members beyond Chinatown's borders when planning significant projects.
- Address issues of public safety through a balanced approach to social service solutions, prevention and enforcement.
- Respect and honour the Indigenous communities who's land we reside on.
- Respect and honour the Chinese/Asian cultures that founded Chinatown and the early migrant workers who first brought the Chinese culture to Calgary.
- Recognize Chinatown for welcoming cultural diversity since the start of the twentieth century.
- Provide English, Simplified Chinese and Traditional Chinese versions of communication materials as much as possible.
- Be intentional about building trusted and informed relationships with the Calgary-Chinese community.

This work aligns with The City's Social Wellbeing Policy (2019), which strives to advance equity for all by removing barriers to access and inclusion.

At The City of Calgary, we endeavor to make life better every day, for everyone.

— The City of Calgary

PROPOSED

BYLAW NUMBER 64P2022

Acknowledgments

Chinatown Advisory Group

The Chinatown Advisory Group is a passionate group of community members whose insights and advice were instrumental to preparing a cultural plan and area redevelopment plan. We sincerely thank all members for your hard work and guidance.

Members

蔡加秋 Lily Jiaqiu Cai
李陳美儀 Liza Chan
Malcolm Chow
馬鳳齡 Fung Ling Feimo
Hong (May) Han 韩红
Ernest Hon
Jeanne Kwong 鄭秋琳
林秀明 Alice Lam
Ken Lee
吴美莲 Dale Lee Kwong
Jamie Leong-Huxley
Aaron Limpin
Christine Louie
Conrad Lowe
Linda Luu
Kasia Nguyen
Arielle Perrotta
Lloyd Sciban 史羅一
黃恕寧 Shu-ning Sciban
蘇賀月華 Grace Su
Ed Tam
Brian Wong
Teresa Woo-Paw
April Xinchu Zhang
Yangfan (Chris) Zheng

Residents of Calgary

Residents of Calgary clearly care for Chinatown. We are grateful to all who attended our meetings, visited our project website, and responded to our online surveys. Thank you for engaging with us and sharing your aspirations for Chinatown.

Community Organizations

Chinatown is served by many organizations who deliver cultural programs, social services and communal spaces to residents. Thank you for sharing your hopes and aspirations with such candor and passion.

Organizations

Calgary Chinatown Community Association
Calgary Chinese Cultural Centre
Calgary Chinese Elderly Citizens' Association
Chinatown Business Improvement Area
Chinatown Development Foundation
Chinatown's societies, Tong Houses
and associations
United Calgary Chinese Association

Landowner, Developer, and Industry Groups

We also greatly appreciate the various landowners, developers and industry groups who engaged with us on numerous topics. Your expertise and keen interest in Chinatown's future is valued.

Urban Alliance

Urban Alliance is a strategic partnership between The City of Calgary and the University of Calgary. Through this partnership, The City commissioned three research projects specific to Chinatown. We thank the professors, associate professors, research assistants and students who worked on these projects to help inform this document.

University of Calgary

Prof. Francisco Alaniz Uribe
Dr. Kwangyul Choi
Dr. Matt Patterson
Dr. Eliot Tretter

PROPOSED

BYLAW NUMBER 64P2022

Contents	1	Introduction	1	2	Vision and core ideas	13
		About the Chinatown Area Redevelopment Plan	2		The vision for Chinatown	14
		Why now?	2		The core ideas for Chinatown	15
		Plan area	3			
		Physical attributes	3			
		Alignment with other plans	5			
		Cultural Plan for Calgary	5			
		Chinatown Cultural Plan	6			
		Calgary Climate Strategy	8			
		Neighbourhood context	9			
		Chinatown's roots	9			
		A neighbourhood in transition	12			

PROPOSED

BYLAW NUMBER 64P2022

3 Land use and density 19

- 3.1 Land use concept 20
 - 3.1.1 Residential Mixed-Use 23
 - 3.1.2 Parks and Civic 25
 - 3.1.3 Comprehensive Planning Sites 30
- 3.2 Density 34
 - 3.2.1 Density areas 34
 - 3.2.2 Density bonusing 36
- 3.3 General policy 42
 - 3.3.1 Climate change mitigation and adaptation 42
 - 3.3.2 Sunlight protection 44
 - 3.3.3 Gateways, landmarks and view corridors 45
 - 3.3.4 Plus 15 network and protected views 47
 - 3.3.5 Housing 48

4 Character areas 49

- 4.1 History, design and character 50
 - 4.1.1 History of Chinatown's design and character 53
 - 4.1.2 How to use design guidance 54
 - 4.1.3 Character defining elements and motifs 55
- 4.2 Character areas policy 57
 - 4.2.1 General 57
 - 4.2.2 Heritage Core 60
 - 4.2.3 Cultural Core 65
 - 4.2.4 Edge area 69

5 Mobility and utility infrastructure 71

- 5.1 Mobility 72
 - 5.1.1 Pedestrian 74
 - 5.1.2 Biking and wheeling 75
 - 5.1.3 Transit 76
 - 5.1.4 Parking 77
 - 5.1.5 Street network 79
- 5.2 Utility infrastructure 80
 - 5.2.1 Utility infrastructure funding 80
 - 5.2.2 Water, sanitary and shallow utility servicing 81
 - 5.2.3 Stormwater management 82
 - 5.2.4 Flood hazard areas 83

PROPOSED

BYLAW NUMBER 64P2022

6 Implementation and interpretation 85

- 6.1 Policy framework 86
 - 6.1.1 Hierarchy of plans 87
- 6.2 Interpretation 88
 - 6.2.1 Policy interpretation 88
 - 6.2.2 Map interpretation 89
 - 6.2.3 Figure interpretation 89
 - 6.2.4 Appendix interpretation 89
 - 6.2.5 Plan limitations 89
 - 6.2.6 Existing caveats/restrictive covenants 89
- 6.3 Implementation 90
 - 6.3.1 Using the Plan 90
 - 6.3.2 Monitoring 90
 - 6.3.3 Review 90
 - 6.3.4 Amendments 90
- 6.4 Glossary 91

A Appendix 95

- Appendix A: Planning and engagement process 96
- Appendix B: Climate risk profile 99
- Appendix C: Public realm strategy 102
- Appendix D: Regional Corridor and Context Map 108

PROPOSED

BYLAW NUMBER 64P2022

Maps

- Map 1:** Context and neighbourhood 4
- Map 2:** Land use concept 22
- Map 3:** Density concept 35
- Map 4:** Character areas 51
- Map 5:** Mobility 73
- Map 6:** Regional corridors and context map 109
- Map 7:** Growth plan placetype alignment 110

Tables

- Table 1:** Density concept 34

Figures

- Figure 1:** Plan context 3
- Figure 2:** Dimensions of Cultural Planning from the Cultural Plan for Calgary 5
- Figure 3:** Key themes of the Chinatown Cultural Plan 7
- Figure 4:** Historic locations of three Chinatowns 11
- Figure 5:** Chinatown standard of local and regional open space 26
- Figure 6:** Concept plan for comprehensive planning site 1 31
- Figure 7:** Concept plan for comprehensive planning site 2 33
- Figure 8:** Gateways, landmarks and view corridors 46
- Figure 9:** Focus and intent of each character area 52
- Figure 10:** Urban design elements framework 54
- Figure 11:** Colonnades 57
- Figure 12:** Built form considerations 58
- Figure 13:** Heritage Core 60
- Figure 14:** Historic examples of characteristic signage on resources in the Heritage Core 62
- Figure 15:** Cultural Core 65
- Figure 16:** Edge area 69
- Figure 17:** Flood protection 84
- Figure 18:** Policy relationship 87
- Figure 19:** Chinatown strategic investments 106
- Figure 20:** Alleyway opportunities 107

PROPOSED

BYLAW NUMBER 64P2022



簡介

简介

1

Introduction

About the Chinatown Area Redevelopment Plan

Chinatown is one of Calgary's most historic and culturally-distinctive neighbourhoods. It's a gateway to downtown and destination for cultural experiences. With development pressures eroding Chinatown's legacy, retaining the community's cultural identity is key for Chinatown to remain a place where people want to live, visit and run their businesses. The **Chinatown Area Redevelopment Plan** is a long-range, statutory (legal) plan that sets out the desired future for redevelopment in Chinatown.

Why now?

Calgary's Chinatown has a distinct history spanning more than a century. It is also part of a larger international story of migration, settlement, perseverance, hardship and prosperity for people of Chinese origin. In countries across the world, many municipalities have areas developed by Chinese immigrants known as "Chinatowns". In North America, these areas originated with Chinese migration in the late nineteenth and early twentieth centuries, brought on by the desire to escape poverty, famine, and homeland unrest to pursue new opportunities.

From their earliest history, Chinatowns were strongly tied to the social, political and economic environment that made them necessary — particularly the structural racism, violence and discriminatory labour and immigration laws that placed onerous challenges on Chinese immigrants. Through individual and collective perseverance, Chinatowns evolved from places where new migrants could access basic services and supports, to become cultural enclaves where Chinese migrants and their families could feel a sense of belonging and safe respite from hostilities outside their "home village".

Today, Chinatowns are valued cultural resources, important economic hubs and highly-sought destinations for tourism and recreation. At the same time, Chinatowns across North America face increasing challenges in maintaining a distinct identity and culture in the context of broader municipal growth. Along with changes brought on by redevelopment, the role and representation of Chinatowns is constantly evolving. They now include a greater variety of Asian businesses and cultures, that represent different ideas to different generations.

To support this valued cultural neighbourhood and address challenges facing Calgary's Chinatown, The City recognized the need to seek innovative solutions. It was clear a new type of planning solution was needed for Chinatown. In response, The City launched the Tomorrow's Chinatown program with a mandate to prepare the first cultural plan in coordination with a new area redevelopment plan in collaboration with the Chinatown community.

The program embraced many innovative approaches, such as:

- Forming a citizen-led Advisory Group to represent community interests.
- Working with the University of Calgary Urban Alliance to conduct research to inform the program and plans.
- Fostering collaboration in developing The City's Chinatown Historical Context Paper (2019) and an independent heritage project, **Heritage Buildings Could Talk: Beyond dim sum, lion dances and empty parking lots**, led by 馬鳳齡 Fung Ling Feimo and produced by Heritage Calgary.

The **Chinatown Area Redevelopment Plan** (the Plan) addresses the unique historical and cultural character of Chinatown. It serves to provide consistency and certainty to the community, developers and decision-makers. Throughout this document you will see how the **Chinatown Cultural Plan** has influenced this Plan through the connections made between cultural identity and land use planning.

PROPOSED

Plan area

Chinatown is located in the north central part of Calgary's Greater Downtown. It is one of several residential mixed-use neighbourhoods that surround the Downtown Core (see Figure 1). The plan area is 24.76 hectares and corresponds to the Census of Canada boundary for Chinatown. It is roughly bounded by the Bow River to the North, Macleod Trail S.E. to the east, 2 Street S.W. to the west, and 3 Avenue S.W. west of Centre Street S. and 4 Avenue S.E. east of Centre Street S. to the south (see Map 1, p. 4).

Figure 1: Plan context

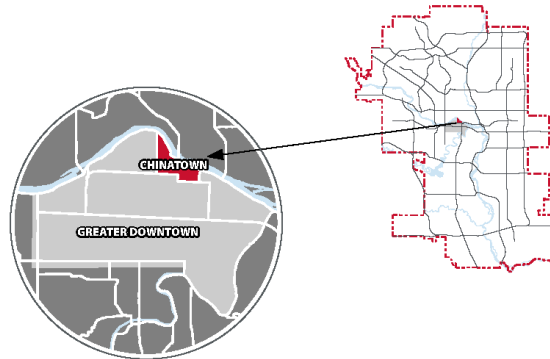

Physical attributes

Location

Chinatown is a key gateway from the north to Greater Downtown, via the iconic Centre Street Bridge. Its picturesque location along the Bow River also connects the neighbourhood to other areas via the river pathway system. This central location makes it an ideal place for investment and growth.

Historic character

Chinatown is centered within a cluster of remaining heritage resources, creating a cohesive sense of identity and place for the community. The heritage buildings, features and streetscapes adjacent to Centre Street S. create a unique urban character.

The Calgary Chinese Cultural Centre has been a neighbourhood focal point since opening in 1992. It provides community space for gathering, festivals and events as well as other cultural education programs. The associated museum also plays an important role in telling the history of Chinese immigrants in Calgary and across Canada.

Green network

The Greater Downtown green network is an interconnected system of regional and local parks, natural spaces and river frontage connected by high-quality, people-focused streets. These are key components to a great neighbourhood. Chinatown is in a prime location within the network, and includes Sien Lok Park, Daqing Plaza, the Bow River and Prince's Island Park. Sien Lok Park is culturally significant with monuments that honour the contributions of Chinese pioneers and Chinese history in Canada.

Public transit system

Chinatown is well connected to other parts of the city through public transit. There is a bus rapid transit line that runs north and south along Centre Street S., and two cross-city train lines a few blocks away. A third train line will have a station on 2 Street S.W. at the edge of the neighbourhood when it's built. Easy transit access is vital to connecting Chinatown with other parts of the city and enhancing connectivity for people wanting to move within Chinatown.

PROPOSED

BYLAW NUMBER 64P2022

Map 1: Context and neighbourhood



Legend

 Plan Area Boundary

Alignment with other plans

Cultural Plan for Calgary

Recognizing that Calgary’s cultural identity was evolving, Council adopted in principle an overall **Cultural Plan for Calgary**. That was in 2016, when Calgary was on the cusp of an economic downturn that continues to persist today. While writing the Cultural Plan, the high unemployment and office vacancy rates emphasized the importance of attracting and retaining talent in diverse industries. It further emphasized the role of placemaking in the city’s cultural identity, particularly in Calgary’s Greater Downtown.

The **Cultural Plan for Calgary** outlines an approach to planning for cultural diversity and vibrancy in Calgary. The Cultural Plan provides:

- An overarching framework to connect existing and future policy and planning initiatives.
- The foundation for integrating cultural planning and decision-making across the city.

As a framework, the Cultural Plan is vital to this area redevelopment plan. Figure 2 shows how the different dimensions of cultural and development planning intersect. Elements such as complete neighbourhoods, urban design, conservation of heritage resources, and placemaking are aspects of the Culture and Place dimensions addressed in this Plan. Together, these documents lead the way for neighbourhood cultural planning in Calgary.

Figure 2: Dimensions of Cultural Planning from the Cultural Plan for Calgary

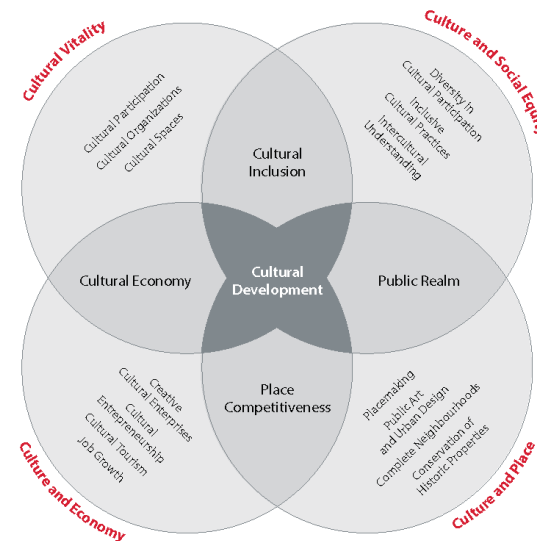

Chinatown Cultural Plan

The **Chinatown Cultural Plan** builds on the foundation laid out by the **Cultural Plan for Calgary**. In the **Cultural Plan for Calgary**, The City adopted an overarching framework for cultural planning that looks at culture as an integrated contribution to every aspect of life and society. This perspective is carried forward into the **Chinatown Cultural Plan** by including how the community perceives its own culture, today and in the future.

This Plan and the **Chinatown Cultural Plan** recognizes and honours the countless contributions that Chinese residents have made to building a thriving Chinatown. It provides support to continue this legacy to ensure Chinatown remains a vibrant place to live, work and do business, for generations to come.

Strategic direction for advancing and investing in the cultural future of Chinatown is outlined in the **Chinatown Cultural Plan** — including cultural experiences and programs; spaces, facilities and amenities; and legacy businesses and tourism. Guidance is provided for setting priorities, forming partnerships, assigning roles and securing resources. The **Chinatown Cultural Plan** also informs and complements this Plan by introducing cultural considerations in the planning process. This will ensure new development does not come at the expense of Chinatown's culture, but instead contributes to what makes the neighbourhood a special place.

The **Chinatown Cultural Plan** is a supporting document developed through extensive community engagement. The community's wisdom, knowledge and contributions are the true authors of the **Chinatown Cultural Plan**. The City is a facilitator, convenor and supporter, but the **Chinatown Cultural Plan** is inspired and led wholly by the community.

The **Chinatown Cultural Plan** provides a framework for five key themes (A to E) that emerged through engagement with the Chinatown community (see Figure 3, p. 7). These themes are:

- A.** People, Voices and Experiences
- B.** Culture, Creative and Learning
- C.** Food, Merchants, and Tourism
- D.** Housing, Health, and Social Purpose
- E.** Place, Spaces and Natural Environment

Each key theme, cultural insight and priority were distilled from community feedback and — where appropriate — incorporated into the Plan as cultural considerations, policies or strategic actions. The objective is to ensure that new development integrates the themes from the **Chinatown Cultural Plan**.

Actions from the **Chinatown Cultural Plan** are highlighted throughout this Plan in shaded boxes, and in actions and maps of Aspirations.

(Source: The City of Calgary, Cultural Plan for Calgary 2016 as prepared by MDB Insight)

PROPOSED

BYLAW NUMBER 64P2022

Figure 3: Key themes of the Chinatown Cultural Plan



A. People, voices and experiences

Tomorrow's Chinatown is a community that celebrates its diversity, and offers people harmony and a sense of belonging.

Strategy A1: Bring cultural groups together

Strategy A2: Build bridges across the generations

Strategy A3: Improve the city-community relationship



B. Culture, creative and learning

Tomorrow's Chinatown is a community known for its artistic production, creativity and opportunities for cultural learning.

Strategy B1: Expand cultural programs and activities

Strategy B2: Secure more space for culture

Strategy B3: Unlock potential of the Cultural Centre



C. Food, merchants and tourism

Tomorrow's Chinatown is a community valued for its independent businesses that offer cultural food, shopping and tourism experiences.

Strategy C1: Support existing and legacy businesses

Strategy C2: Attract new enterprises and concepts

Strategy C3: Create a year-round visitor experience



D. Housing, health and social purpose

Tomorrow's Chinatown is a community that provides residents the housing and support services they need, throughout all life stages.

Strategy D1: Invest in an all-generations community

Strategy D2: Contribute to the lives of all Calgarians

Strategy D3: Sustain the traditional tongs and societies



E. Places, spaces and natural environment

Tomorrow's Chinatown is a community that expresses its culture, history and stories in the physical environment.

Strategy E1: Design streets for culture and people

Strategy E2: Revive heritage to benefit community

Strategy E3: Strengthen Chinatown's contours

Calgary Climate Strategy

The effects of climate change are evident in Calgary with more frequent and severe weather events. Climate change hazards will continue to intensify. Current and future climate change impacts require The City to educate, motivate and mandate climate mitigation and adaptation actions across Calgary, including Chinatown.

The City declared a Climate Emergency in 2021 to enable a coordinated approach to:

- implementing effective management practices;
- setting policy direction;
- prioritizing budgets; and,
- providing strategic oversight.

A climate risk profile created for Chinatown (see Appendix B, p. 99) informs the policies and guidelines contained in this Plan. The intention is to support Chinatown's transition toward a low-carbon economy and a more resilient and sustainable future.

The **Calgary Climate Strategy** (the Strategy) outlines The City's path to achieving net zero emissions by 2050 and becoming more climate resilient in alignment with local, provincial, national and international policy. To meet this ambitious target, the Strategy focuses on supporting a low-carbon future and reducing climate impacts by:

- Defining The City's role in transitioning Calgary to a low carbon economy, while supporting sustainable growth.
- Supporting development of interim milestones for climate mitigation, including specific programs and actions to reduce greenhouse gas emissions.
- Developing climate adaptation measures to help manage climate risks to our built infrastructure, environment, economy and people.
- Creating and implementing programs and actions, while tracking and reporting progress and achievements.

See Appendix B (p. 99) for the Climate risk profile for Chinatown.

The Strategy and the associated Mitigation and Adaptation Plans are non-statutory documents. However, by including climate actions in legislated planning tools, such as this Plan and available development review and approvals processes, The City is empowered to implement the Strategy.

Climate mitigation

Almost all annual greenhouse gas emissions produced in Chinatown come from carbon-intensive energy sources used to heat and cool buildings and fuel vehicles. Reducing emissions by decreasing reliance on private vehicles and improving the energy efficiency of buildings directly translates to reduced energy use and costs. Further, when comparing low carbon development and mobility options with "business as usual" practices, research shows that shifting to a lower carbon development path for Chinatown (and Calgary as a whole) is economically and technologically viable.

Climate adaptation

Adjacent to the Bow River, Chinatown is within the heavily urbanized area of Calgary that accommodates a mix of old and new buildings. Extreme heat events, Bow River flooding and heavy rainfall events pose the most significant climate risks for Chinatown. The Plan seeks to address these risks by:

- increasing the climate resilience of buildings and infrastructure;
- assisting citizens to manage, respond and adapt; and,
- leveraging the innate resiliency of natural infrastructure in the community.

Neighbourhood context

Chinatown's roots

Many early Chinese immigrants were railroad workers in British Columbia who worked on the transcontinental railway. When it was completed in the mid-1880s, and the promise of a return fare to China wasn't honoured, some migrated to Calgary. They established the first Chinatown location in 1885, along 8 Avenue S.E. near the current City of Calgary Municipal Building (see Figure 4, p. 11).

The small community at the time persevered through a fire that destroyed half the neighbourhood in 1886, followed by the Smallpox Riot in 1892. That event saw hundreds of rioters who were incensed over a racialized public health threat, vandalized businesses, injured residents and threatened other Chinese migrants and businesses from coming to the city. Despite these systemic and violent manifestations of racism and anti-immigrant sentiments, the Chinese community continued to grow. Needing more space, a second Chinatown evolved around 1901 between 10 and 11 Avenue S.W. and between 1 and 4 Street S.W. (see Figure 4, p. 11). Property values grew rapidly when a new hotel and railway were proposed for the area. This led to profitable land sales which forced Chinese tenants to relocate once again.



Sourced from Chinatown Context Paper, Glenbow Archives PD-39-182



Canton Block, constructed in 1910
Glenbow Archives NC-24-52

To avoid future displacement, a group of Chinese businesspeople worked to purchase land on Centre Street S. and 2 Avenue S. Their plans were briefly stalled by anti-Chinese protesters demanding Chinatown be located elsewhere. Through negotiations with City Council, the Chinese business group prevailed. The City issued their permit to build the Canton Block in 1910. The Canton Block became the foundation of the Chinese community's permanent home in Calgary.

Although population growth was still inhibited due to the Chinese Immigration Act(s), the neighbourhood was mostly built-out over the following decades. Chinese businesses operating out of new commercial buildings and the homes built around them created a self-sustaining core. This allowed the Chinese community to flourish. Social organizations further strengthened the community and helped newcomers get established. This intertwining of the built and cultural landscapes was vital to the deep roots established in this place.

Head Tax & The Chinese Exclusion Act

In 1885, immediately after construction on the Canadian Pacific Railway was complete, the Federal Government passed the Chinese Immigration Act. It stipulated that every person of Chinese origin immigrating to Canada had to pay a fee of \$50, called a head tax, with almost no exceptions. In 1900, the head tax increased to \$100 per person. Three years later, it rose again to \$500 per person. The head tax was in effect until 1923 when it was replaced by a new Chinese Immigration Act (Chinese Exclusion Act) which essentially banned all Chinese immigration to Canada until 1947.

Source: The Canadian Museum for Human Rights, website: humanrights.ca

PROPOSED

BYLAW NUMBER 64P2022

Beyond the overtly racist laws, policies and sentiments the community faced in its early years, the twentieth century saw Chinatown's existence threatened multiple times by urban renewal proposals. The 1947 discovery of oil in Leduc, Alberta prompted rapid growth in the downtown area, and the role of Chinatown in relation to the prospering city as a whole began to shift. In the 1960s and 1970s, several large-scale infrastructure projects were proposed along the south bank of the Bow River. One, a 12-lane freeway, would require Chinatown to relocate again while substantially altering the character of Calgary's downtown. Community members in Chinatown campaigned heavily against the proposals, with a newly-formed Sien Lok Society organizing a 'National Conference on Urban Renewal as It Affects Chinatowns'. The community's efforts to halt these mega-projects succeeded, and led to a 1976 Chinatown Design Brief and subsequent 1986 Chinatown Area Redevelopment Plan. This initiated a new 'revitalization period' for Chinatown. While most urban renewal projects were abandoned in Chinatown, the Harry Hays Building was approved and built (1974-78) filling two blocks at the east end. To accommodate construction, land was expropriated and 30 homes were demolished, displacing more than 200 residents.



Calgary Chinese Cultural Centre, constructed in 1992

In the decades since the 1976 Design Brief and 1986 Chinatown Area Redevelopment Plan, Chinatown continued to develop. Neighbourhood amenities such as the Calgary Chinese Cultural Centre and Sien Lok Park were built. Dragon City Mall and other commercial properties were developed. Senior housing was created to support the community's aging demographics. Visual and public realm improvements enhanced Chinatown's appearance and urban experience. While select infill projects have satisfied some redevelopment interest, concerns remain over the preservation of Chinatown's appearance, identity and culture.



Chinatown Park archway, constructed in 1984/1985

The historical information outlined in The Plan is drawn from the **Chinatown Historical Context Paper** (2019). Refer to the paper along with other community, academic and archival sources to further explore Chinatown's ongoing heritage.

PROPOSED

BYLAW NUMBER 64P2022

Figure 4: Historic locations of three Chinatowns



The illustration is for conceptual purposes only and is based on a map in the Chinatown Historical Context Paper. Chinatown's three locations, Chuenyan David Lai 1988, p.88

A neighbourhood in transition

Demographic trends in Chinatown are shifting. Civic census data shows its population grew 89 per cent between 2007 and 2019, to a peak of 2,471 residents in 2019. Between 1984 and 2004, the increasing majority of residents were 65 and older. Then, starting in 2004, the 25 to 44 age group began growing. As of 2019 data, this younger age group remains the largest for the neighbourhood.

Approximately 28 per cent of Chinatown's population are over 65. This is a significantly higher percentage compared to other age groups and most neighbourhoods. Seniors have traditionally played a valued role in the community and continue to be a crucial voice in planning Chinatown's future. The challenge now is harmonizing the changing demographic in age groups, to maintain the needs and sense of place for older residents.

Chinatown still provides a safe haven for newcomers to Canada, including those of different nationalities and ethnicities. Immigrants remain a large proportion of Chinatown's population, at 66 per cent in 2016. Overall the percentage of people of Chinese ethnic origin has decreased from 84 per cent in 2006, to 53 per cent of Chinatown's total population (Source: 2006 Census of Canada and 2016 Census of Canada, Statistics Canada). The increased diversity presents an opportunity for a larger population base to support the local Chinatown economy. Chinatown is and has historically been an area that welcomes visitors to experience Chinese culture. Today, the local businesses and languages visible on signage indicate an evolving Chinese/Asian culture.

Thirty years from now, Chinatown is projected to be home to more than 5,000 residents living in up to 1,600 housing units. Business growth is projected to provide more than 5,000 jobs. The neighbourhood will continue to be a unique destination for the region and provide important cultural and civic amenities supporting its local population (Source: Scenario Series Population and Employment Projections, City of Calgary).

Despite decades of change, Chinatown's built environment remains significant to the community's sense of belonging and deeply embedded support networks. Chinatown is the cultural, historical and symbolic home of the Chinese-Calgarian community. The neighbourhood functions to support and celebrate a common belonging for its residents and businesses, as well as people from outside the community. The historical core around Centre Street S., 2 and 3 Avenue S. anchors the neighbourhood and typically comes to mind first when thinking about the unique identity of Chinatown. Residential and support providers have historically centered around this core. The mix of uses (such as Tong Houses and community organizations) in this core creates seamless and natural transitions between public, semi-private and private spaces. This form of integration is unique to Chinatown and crucial to its built evolution. Chinatown embodies the most important components that make a neighbourhood culturally-supportive for all generations.

As Chinatown transitions and evolves over the lifetime of this Plan, it's critical to maintain harmony within and between the social, cultural, economic and physical functions of the neighbourhood. Redevelopment today and in the future must reflect Chinatown's unique character and function while balancing the need for growth and innovative evolution.

PROPOSED

BYLAW NUMBER 64P2022



2

**Vision and
core ideas**

願景與核心理念

愿景与核心理念

PROPOSED

BYLAW NUMBER 64P2022

The vision for Chinatown

Chinatown is a distinct and supportive neighbourhood with a long, culturally rich history. It is an adaptable and authentic place that respects and celebrates diversity. Chinatown will continue to be a valued, affordable and attractive residential neighbourhood, accommodating a diverse population with varied housing options. Its unique neighbourhood character and historical significance will continue to be expressed and preserved through its built environment. Chinatown's vibrant streets and eclectic commercial offerings will support a thriving local economy and enhance individual health and harmony.

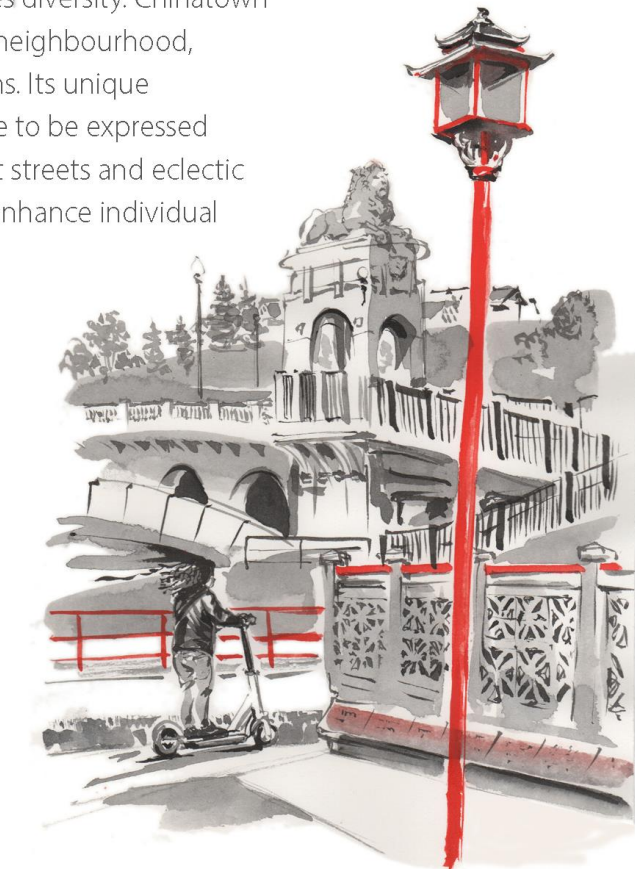

The core ideas for Chinatown

The **Chinatown Area Redevelopment Plan** is the vision for guiding growth and change in Chinatown. The community's hopes, fears and desires for its future were voiced through engagement and helped prioritize aspirations for the neighbourhood. Informed by the five key themes that make up the Chinatown Cultural Plan, these core ideas build on the vision and express a sought-after end state for the neighbourhood. The vision and core ideas are the objectives of the Plan and were used to shape the policies, which are how the objectives will be achieved.

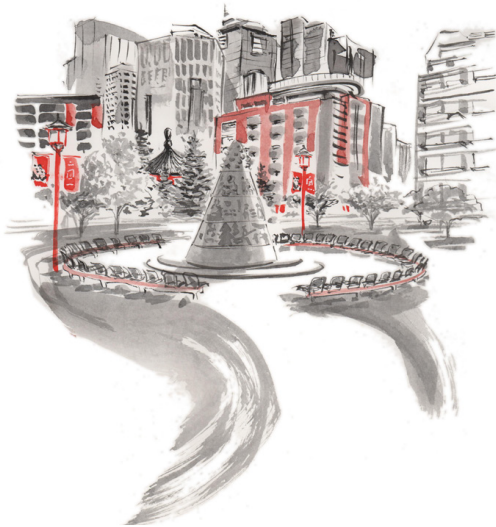

Chinatown is an affordable and attractive residential neighbourhood

Chinatown has housing choices that respond to community needs. They support daily life with easy access to open space, services and amenities, and respond to current and future challenges facing the community.

Affordability

Create affordable housing in Chinatown so the neighbourhood remains a gateway for newcomers and others wanting a home with close-knit community support systems.

Multigenerational living

Provide culturally-appropriate housing choices that enable families to live with or in close proximity to each other. Sustain a neighbourhood where young people, families and seniors find a home and care for one another.

Supporting daily life

Provide culturally-inspired parks and open spaces for all ages and abilities to accommodate a variety of activities. Ensure a mix of services and community amenities are accessible to all.

Climate resilient

Implement climate actions to support emissions reduction and enable development that is safe, resilient, affordable and enjoyable for all who live or visit Chinatown.

PROPOSED

BYLAW NUMBER 64P2022

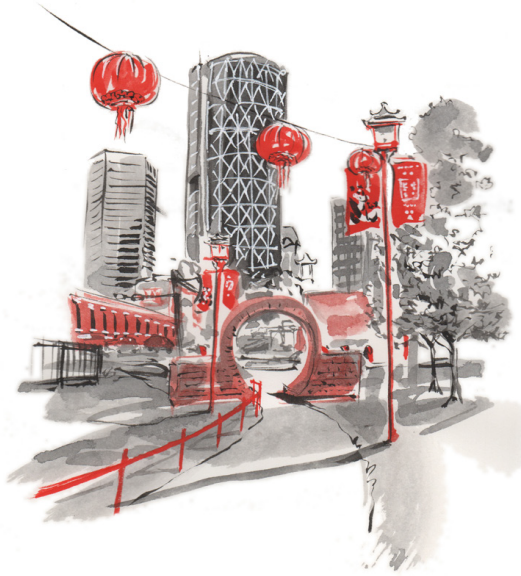

Chinatown's unique neighbourhood character continues to be expressed through its built environment

Streetscapes, building scale, architecture, signage and art reflect Chinatown's culture.

Strengthen the edges

Strengthen the neighbourhood edges through growth and public realm design that reflect Chinatown's culture. These areas are gateways into the neighbourhood and draw people in through their identifiable character.

Contextual development

Allow a range of visual expression and cultural representation of Chinatown through development that respects the neighbourhood context.

Cultural reference

Integrate appropriate cultural references in site and landscape design, as well as architecture and signage. Enhance the user experience through bilingual (English/Traditional Chinese) signage.

Chinatown's historic significance is preserved

Built heritage sites in Chinatown remain meaningful and accessible. Adjacent growth contributes to the importance of these sites.

Conservation of heritage

Conserve existing heritage resources, such as storefronts, streetscapes and alleyways to ensure continued use in everyday life. This may happen through preservation or rejuvenation, or by adding sites to Calgary's Inventory of Evaluated Historic Resources.

Historic rhythm of streets

Reinforce the traditional rhythm of Chinatown's streets through infill that integrates with the look and feel of adjacent heritage resources.

PROPOSED

BYLAW NUMBER 64P2022



Chinatown's vibrant streets and eclectic commercial offerings support a thriving local economy

Chinatown's pedestrian corridors are vibrant. Bolstered by a high-density residential base, these corridors are lined with a mix of small-scale retail shops and restaurants. A lively economic spirit is a core characteristic of Chinatown that supports residents and welcomes visitors.

Neighbourhood connections

Improve neighbourhood connections within and beyond Chinatown by ensuring streets are walkable and comfortable. Increase foot-traffic, cycling and scooting from adjacent neighbourhoods, the riverfront and transit stations and stops.

Historic commercial character

Offer regulatory flexibility for commercial and cultural uses. Limit the number and size of large commercial and office uses at street level to help preserve Chinatown's commercial character.

Year-round experiences

Create exciting places to support a strong economy and attract people for year-round experiences. Design spaces to be comfortable in all seasons to entice people to spend time in the neighbourhood.

PROPOSED

BYLAW NUMBER 64P2022



Chinatown supports community, family and individual health and harmony

Chinatown has deeply-embedded support networks that are critical for individuals, particularly seniors and immigrants, and their families. Cultural, family and social associations play a key role in forming these networks. Also important is growing the sense of belonging in the community. Arts, festivals and events bring people together to celebrate a shared cultural heritage.

Purposeful community space

Provide purposeful community, arts and cultural spaces that are accessible and functional for a variety of groups. These spaces are crucial for the support networks in the community. Request space in new development for these purposes to sustain Chinatown as a home for the community.

Spaces for celebration

Provide public and private gathering spaces in Chinatown that are well-connected and can be activated through adjacent uses and events. These spaces may accommodate large festivals, social gatherings or pop-up events where arts and culture in the community are openly celebrated.

PROPOSED

BYLAW NUMBER 64P2022



3

Land use
and density

土地用途與密度

土地用途与密度

PROPOSED

BYLAW NUMBER 64P2022

3.1 Land use concept

This Plan sets out a framework for redevelopment that recognizes and celebrates the elements that make up Chinatown. The Plan provides opportunities for more people to live and work in Chinatown, which allows for a better use of land and public infrastructure. The land use and density concepts are aligned with Calgary's Municipal Development Plan (MDP) objectives: encouraging a more compact urban form, creating complete communities, and improving neighbourhood vitality and character.

This chapter provides the Land Use Concept (see Map 2 on p. 22), the Density Concept (see Map 3 on p. 35) and general policies for the Chinatown neighbourhood. Collectively, these policies guide redevelopment in the neighbourhood. All development should generally comply with the maps and policies from the Plan.



PROPOSED

BYLAW NUMBER 64P2022

The Land Use Concept for Chinatown reaffirms the area as a residential mixed-use neighbourhood. It supports important connections to the Bow River through parks, open space and natural areas. The Plan envisions roles for the primary streets:

- Centre Streets S. as a High Street and a gateway to the neighbourhood;
- 2 and 3 Avenues S. as commercial streets providing neighbourhood connections from east to west and indirectly to the river; and,
- 1 Street S.W. and 2 Street S.W. as important connectors to the public transit system and neighbouring areas.

These streets support high levels of activity and include a broad mix of uses. Activity levels are accommodated through sensitively designed buildings with cultural references that support a high-quality public space and street experience. These are, and will continue to be, the streets with the greatest number of people using them, enjoying shops and restaurants on wide sidewalks with a public space that offers opportunities to sit, socialize and watch street life.

The Land Use Concept identifies two comprehensive planning sites. These two sites are considered comprehensive to address specific issues or situations that are not addressed by the Plan's broader land use classifications or policies. A determination of the precise boundaries of each comprehensive planning site will be made by the approving authority at land use or development permit stages.



PROPOSED

BYLAW NUMBER 64P2022

Map 2: Land use concept



PROPOSED

BYLAW NUMBER 64P2022



Chinatown Cultural Plan

Culturally relevant health services are much needed, including Traditional Chinese medicine, a Chinese-speaking family physician, dentist, walk-in clinic and health lab.

— **Action D1.3**

3.1.1 Residential Mixed-Use

Residential Mixed-Use is a range and mix of uses in many possible configurations. Buildings are oriented to the street with commercial use units on the ground floor and a range of uses located behind or above. Commercial frontages have many entrances and windows along the street to encourage pedestrian activity. Some uses may be restricted or prohibited where they are beside or in close proximity to Primary Transit.

Density shall be measured by Floor Area Ratio (FAR). FAR means the quotient of the gross floor area of a building divided by the gross site area.

Policies in the Plan are intended to apply in addition to the policies found in Chapter 4: Urban Design in the Centre City Guidebook, MDP Vol 2, Part 2.

Policy

Land use

- a. Land use designations should be consistent with the land uses shown on Map 2: Land Use Concept and the densities shown on Map 3: Density Concept.
- b. Commercial uses on the ground floor are allowed in all buildings.
- c. No new single-use office development should be allowed.
- d. The following new uses should not be allowed:
 - i. drive-through facilities;
 - ii. fuel stations;
 - iii. auto shops;
 - iv. primary function at-grade permanent or temporary parking lots; and,
 - v. single-use parkades.
- e. For development of 4.0 FAR or higher, 60 per cent of total gross floor area of all new buildings, at full build out, should be residential uses.

Site, building and landscape design

- f. Applications for new development of buildings over 12 storeys in height should provide a Pedestrian Wind Comfort and Safety Study. The study should:
 - i. outline pedestrian level wind impact on the public realm including sidewalks and street frontages, building entrance areas, surrounding open spaces and rooftop amenity areas;
 - ii. identify mitigation strategies to decrease the effects of the wind such as building massing, podium articulation, canopies and landscaping; and,
 - iii. anticipate future changes to wind intensity and severe wind event frequency due to climate change.
- g. To enhance neighbourhood character and identity, a comprehensive lighting plan, including experiential lighting, may be required.

- h. A comprehensive lighting plan should highlight the site and/or building, animate the evening environment, ensure pedestrian safety, minimize glare and mitigate illumination of neighbouring properties.
- i. A comprehensive lighting plan, including experiential lighting, should be provided for sites and buildings proposed in the following locations:
 - i. along active frontages, at neighbourhood gateways and along landmark view corridors;
 - ii. where there are architectural landmarks (contemporary, historic or cultural) and at tall buildings that have an impact on the overall skyline; and,
 - iii. within, on, or under the Plus 15 bridges and at grade entrances to the Plus 15 network.

PROPOSED

BYLAW NUMBER 64P2022



Chinatown Cultural Plan

The appeal of storefronts needs to be revived with freshened-up façades and interiors that make products and activities visible from the street. An incentive program could stimulate businesses and landlords to invest. — **Action C1.3**

Storefront façades can become exhibits that pay homage to the stories, cultural values, entrepreneurship and resilience of the Chinatown community. — **Theme A Map of Aspirations (E)**

- j. Development in Residential Mixed-Use areas should locate building utilities such as meters, mechanical boxes, and ventilation shafts within the development site in a location that is fully screened from view of the public realm.
- k. Rooftop mechanical equipment and elevator penthouses should be well integrated with the architectural design and screened from pedestrian view.
- l. Where landscape screening is proposed in the setback, the planting medium should be of appropriate composition and adequate width and depth to support healthy plant development.

Active frontages

To create a high-quality and vibrant pedestrian environment on sidewalks and in public spaces, active frontages have been identified on Map 2. These building frontages should be designed to activate the sidewalk, prioritizing pedestrian movement and minimizing interruptions for access and loading. Less active uses, such as residential, office or institutional uses, are encouraged behind these more active uses or on upper floors.

In addition to the frontage policies in Chapter 4: Urban Design in the Centre City Guidebook, MDP Vol 2, Part 2, the following policies apply:

- m. Development in Active Frontage areas should:
 - i. have a minimum floor-to-ceiling height of 4.0 metres to support a range of active uses over time;
 - ii. provide frequent entrances and windows that maximize views to and from the street; and,

- iii. use building articulation to provide a well-defined, continuous street wall and improve the pedestrian experience using varied textures and high-quality building materials.
- n. Encourage development in Active Frontage areas to:
 - i. integrate larger commercial or residential uses behind or above smaller commercial units facing the street; and,
 - ii. include additional building setbacks to accommodate an extension of the use outside of the building, such as patios and display areas.
- o. Development along Active Frontages (see Map 2, p. 22) and located at street corners should articulate the corner space by locating entrances on corners and/or wrapping active uses around the building. This articulation should be carried from ground level through to the upper levels of the street wall.

3.1.2 Parks and Civic

This Parks and Civic areas section includes three land use categories: Parks and Open Space, Natural Areas and City Civic. These areas are centres of neighbourhood activity and greatly contribute to sense of place. They provide a range of opportunities for social interactions including play, rest, recreation and gatherings. These areas encourage community unity, cultural vitality and support individual health and well-being. Community parks and open spaces in Chinatown are an important part of the cultural history of the neighbourhood and are also key attractions for tourists and residents.

In addition to the general policies in Section 3.1.1, the following policies apply:

Policy

Site, Building and Landscape Design

- a. Consider incremental site improvements, to be assessed periodically, including, but not limited to:
 - i. improving connections to the neighbourhood and to other parks and open spaces;
 - ii. improving the public realm to strengthen the sense of place and encourage social gathering as well as cultural and recreation activities through elements such as public art, street furniture, seating areas and enhanced landscaping;
 - iii. providing additional programming, events, cultural spaces or facilities;
 - iv. protecting, rehabilitating, and enhancing natural areas;
 - v. improving accessibility; and
 - vi. providing additional services, such as electrical and water service to allow for future facilities and capacity to support festival activities, where feasible.
- b. Mobile vendors and kiosks may be allowed temporarily in public Parks and Civic areas.
- c. Public and publicly accessible areas should be designed to:
 - i. be centrally located and adequately sized to the development;
 - ii. maximize safety, comfort and all-season enjoyment;
 - iii. be adaptable to a variety of activities and programming;
 - iv. be well landscaped to provide buffering from adjacent auto traffic;
 - v. include lighting and furniture;
 - vi. maximize sunlight while providing access to shaded areas; and,
 - vii. mitigate negative wind impacts using landscaping.
- d. Buildings and facilities should:
 - i. be located to maximize accessibility;
 - ii. provide running water, power and washroom facilities;
 - iii. be oriented to minimize negative impacts, such as shadowing;
 - iv. be made of materials that complement surrounding areas;
 - v. provide shelter to allow for year-round use, where appropriate; and,
 - vi. consider design that allows indoor spaces to open to the outdoors.
- e. Support wildlife and pollinators by providing appropriate habitat.
- f. Consider alternative and innovative approaches to provide opportunities for play, physical activity and social connection for all ages and abilities, particularly young children and seniors.

PROPOSED

BYLAW NUMBER 64P2022



Chinatown Cultural Plan

More culturally inspired outdoor spaces should be dedicated to play and exercise for all ages. — **Action D1.4**

Figure 5: Chinatown standard of local and regional open space

Population in Chinatown is projected to grow to more than 5,000 residents by 2049. Ensure there is sufficient open space in Chinatown by using the minimum quantity standard of 1.0 hectare of local and regional open space per 1,000 residents.

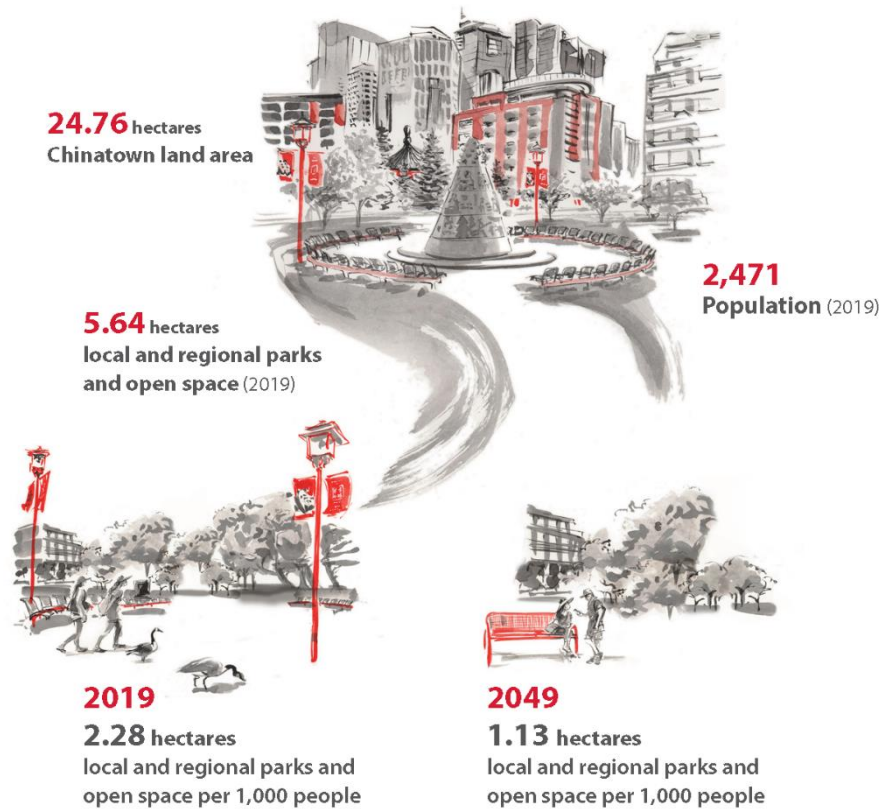

PROPOSED

BYLAW NUMBER 64P2022



Chinatown Cultural Plan

Opportunities exist to apply Eastern garden philosophies more widely. Examples include Chinese garden designs in streets, parks and at senior housing, vegetable gardens and (indoor) edible landscapes. — **Action E1.4**

Sien Lok Park and 和園 Harmony Park would benefit from more amenities, such as bike parking and rentals, a park pavilion, food trucks, (covered) seating, dog parks, playgrounds and community gardens. — **Action E3.1**

An open or enclosed pavilion in Sien Lok Park could offer a place to have tea with friends or family, listen to a performance, rent bikes or explore what else is happening nearby. — **Theme E Map of Aspirations (A)**

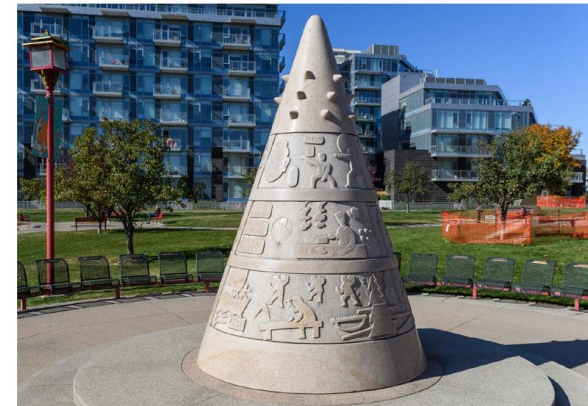

Chinatown Area Redevelopment Plan

3.1.2.1 Parks and Open Space

Parks and Open Space areas are outdoor spaces that are accessible to the public and support recreational, cultural and spiritual uses. They also provide service benefits such as food and water, and regulating services such as the regulation of floods, drought and land degradation.

In addition to the general policies in Section 3.1.1, the following policies apply:

Policy

Land Use

- a. Parks and Open Space areas may accommodate:
 - i. a range of uses that support the primary function of these open spaces such as community uses and community gardens;
 - ii. educational, athletic, cultural, creative, and social programming;
 - iii. commercial services or pop-up and temporary uses that complement the primary function of the site, where possible;
 - iv. public education programming and interpretive information about local history and ecosystems; and,
 - v. festival and event spaces.
- b. Ensure sufficient open space in Chinatown using a minimum quantity standard of 1.0 hectare of local and regional open space per 1000 residents.
- c. There shall be no loss of current local or regional open space within the plan area.

Site, Building and Landscape Design

- d. Parks and Open Space areas should be designed to:
 - i. reinforce the character and heritage of the Chinatown neighbourhood;
 - ii. celebrate the diversity, culture, art and history of the community;
 - iii. protect existing trees and ensure adequate soil volume to support tree health and growth;
 - iv. support programming in all seasons;
 - v. use landscaped areas to delineate open space and property boundaries, where possible; and,
 - vi. identify and integrate cultural landscapes in their design and layout.
- e. New or redeveloped Parks and Open Space areas should include significant areas of soft landscaping, with a recommended target of 50 per cent of the park area. The intent is for this to provide people with an area of respite in the heavily urbanized environment, to reduce the urban heat island effect, and to enhance the capacity of parks to sequester carbon dioxide. Native plant species that have better carbon sequestration capacity should be prioritized.

PROPOSED

BYLAW NUMBER 64P2022



Chinatown Cultural Plan

Despite Calgary's climate, a classical Chinese garden is certainly feasible. Sien Lok Park or the eastern section of Prince's Island Park could be good locations for this. —

Theme E Map of Aspirations (C)

3.1.2.2 Natural Areas

Natural Areas in the city are characterized as areas that offer a range of ecological functions and benefits, from improving air and water quality to supporting biodiversity (that is protecting native vegetation and providing wildlife habitat). These areas may include a range of amenities such as pathways, parks, river access points, washrooms, gathering spaces and interpretative features.

In addition to the general policies in Section 3.1.1, the following policies apply:

Policy

Land use

- a. The natural characteristics and function of the land should be protected as natural areas that contribute to biodiversity and provide ecosystem services.
- b. Human uses and activities at and adjacent to the Natural Areas should be designed and managed in order to mitigate negative impacts to natural areas.
- ii. integrating bioengineering techniques into bank restoration where feasible, including areas where hard infrastructure needs to be replaced.
- e. Pathways and trails adjacent to and within Natural Areas should be designed and constructed to minimize disturbance to the Natural Area and create a buffer between the Natural Area and adjacent development.

Site, building and landscape design

- c. Natural Areas should:
 - i. support the protection, preservation and rehabilitation of ecological processes and functions; and,
 - ii. support the presence of wildlife and pollinators and provide habitat and movement corridors by connecting parks and open spaces with natural areas.
- d. Riparian health along the Bow River in Chinatown should be improved by:
 - i. prioritizing areas for possible improvements (i.e. banks with poor or moderate health; riparian zones that are unhealthy or healthy with problems); and,
 - ii. allowing for modification of natural areas, to enhance the overall habitat condition and increase their capacity to incorporate a buffer for more sensitive areas.
- f. The protection of the riverfront/riparian areas should be planned and supported to buffer incompatible uses by:
 - i. strategically protecting areas adjacent to waterways to safeguard freshwater resources; and,
 - ii. allowing for modification of natural areas, to enhance the overall habitat condition and increase their capacity to incorporate a buffer for more sensitive areas.
- g. A minimum 35-metre-wide zone from the top of bank of the Bow River to any development parcel in Chinatown should be maintained to accommodate the regional pathway, protect bio-diversity and provide pedestrian access to the riverbank.



PROPOSED

BYLAW NUMBER 64P2022

3.1.2.3 City Civic

City Civic areas in Chinatown are characterized by indoor and outdoor facilities located on public land. These areas may include a range of accessible programmable spaces, such as athletic, arts, and cultural amenities. Facilities on these sites provide spaces to gather, celebrate, learn and play. The private sector, public sector, non-profit agencies, charities and partnerships amongst them may play a role in the ownership, operation and development of these neighbourhood assets.

The Calgary Chinese Cultural Centre and the Calgary Chinatown Seniors' Centre are located within City Civic areas. These facilities are important amenities in Chinatown providing a venue for cultural events and festival as well as offering community space to gather and socialize. Though on City-owned lands, these facilities are leased and operated by local associations. Continued support and investment in these facilities is necessary to allow them to continue to thrive.

In addition to the general policies in Section 3.1.1, the following policies apply:

Policy

Land use

- a. Support the integration of recreation uses into existing and new facilities and spaces to create multi-purpose and multi-use amenities.
- b. All types of special care facilities and affordable housing are appropriate in City Civic areas and are encouraged to locate where there is convenient access to community services and amenities.

Site, building and landscape design

- c. Enhance the functionality of neighbourhood facilities and spaces through the inclusion of infrastructure such as lights, electricity, drinking fountains, water, and washrooms to allow for a range of accessible activities.

d. Redevelopment in City Civic areas should:

- i. include adaptable spaces and amenities that respond to diverse needs in the community, in all seasons;
- ii. include adequate servicing, access, space, and facilities based on the size and function of the area to support community gatherings, festivals, cultural activities and special events; and,
- iii. consider programming and services that encourage artistic, cultural, sport and recreational enrichment to promote a more vibrant, healthy, active, safe, and caring community for the enjoyment of all community members.



- e. City Civic areas may have uses that attract a high number of people. Redevelopment in and around City Civic areas should mitigate impacts by considering:
 - i. pedestrian connections to adjacent transit stops and pathways;
 - ii. on-site pedestrian routes to minimize conflicts with vehicles, particularly near access and service areas;
 - iii. location of parking areas to support activities on the site; and,
 - iv. screening from adjacent uses.



Chinatown Cultural Plan

The spaces west (Daqing Square) and east (Daqing Ave) of the [Cultural] Centre can be upgraded into vibrant plazas that accommodate cultural events in all seasons, while improving connections with the greater community. — **Action B3.2**

Movable or fixed canopies, tents, light fixtures and street furniture would turn spaces like Daqing Square into vibrant plazas that can host cultural events all through the year, rain or shine. — **Theme B Map of Aspirations (D)**

3.1.3 Comprehensive Planning Sites

3.1.3.1 Comprehensive Planning Site 1: Adjacent to the future LRT station

Intent

Comprehensive Planning Site 1 (see Map 2, p. 22) focuses on the importance of integrating this site with the future LRT station (see Figure 6, p. 31). This site will support intensification through new buildings that frame the public streets and open space, improved connections for people traveling in the area and comfortable experiences for people walking and wheeling.

This site is important for realizing Chinatown's vision as a residential neighbourhood that is supported by a variety of commercial uses and mobility options. It offers significant placemaking opportunities for a new culturally appropriate development that strengthens the western edge of the neighbourhood.

In addition to the general policies in Section 3.1.1, the following policies apply:

Policy

Land Use

- a. Land uses should be consistent with the intent for a comprehensive mixed-use development with a required minimum density of 7.0 FAR.
- b. New development may include up to six storeys of non-residential uses within a building podium.

Site, Building and Landscape Design

- c. At the time of redevelopment, a comprehensive site plan should be provided and establish:
 - i. an internal pedestrian network;
 - ii. the location of buildings that focus on place-making; and,
 - iii. the incorporation of Active and Open Space Frontages (see Map 2, p. 22), on-site open spaces, pedestrian passageways and pedestrian amenities.

d. East-west pedestrian and wheeling connections through the site and Daqing Square should be established to make it easy and direct for people to connect from the future LRT station to the east part of Chinatown.

e. In addition to the policy in Section 3.3.2, the height and positioning of buildings on this site should maximize sunlight penetration to on-site open spaces and the public sidewalk area along the north side of Riverfront Avenue S.W.

f. A minimum of 2,675 square metres of publicly accessible private open space shall be provided and integrated with Daqing Square. The 2,675 square metres includes the amount of public realm setback defined in the Land Use Bylaw.

g. Servicing and loading functions, and access to parkades and building mechanical systems such as ventilation screens, should be strategically located to minimize impact on the 2 Street S.W. and 2 Avenue S.W. streetscapes as well as Daqing Square.

h. Buildings and site design elements should reflect the cultural and historic significance of the neighbourhood and reinforce Chinese/Asian motifs (see Section 4.1.3, p. 55/56). Particular focus should be placed on the building façades facing the future LRT station, open spaces and street corners at 2 Avenue S.W. and Riverfront Avenue S.W.

i. Lobbies of residential buildings and at-grade residential units should not front onto 2 Street S.W.

PROPOSED

BYLAW NUMBER 64P2022

Figure 6: Concept plan for comprehensive planning site 1

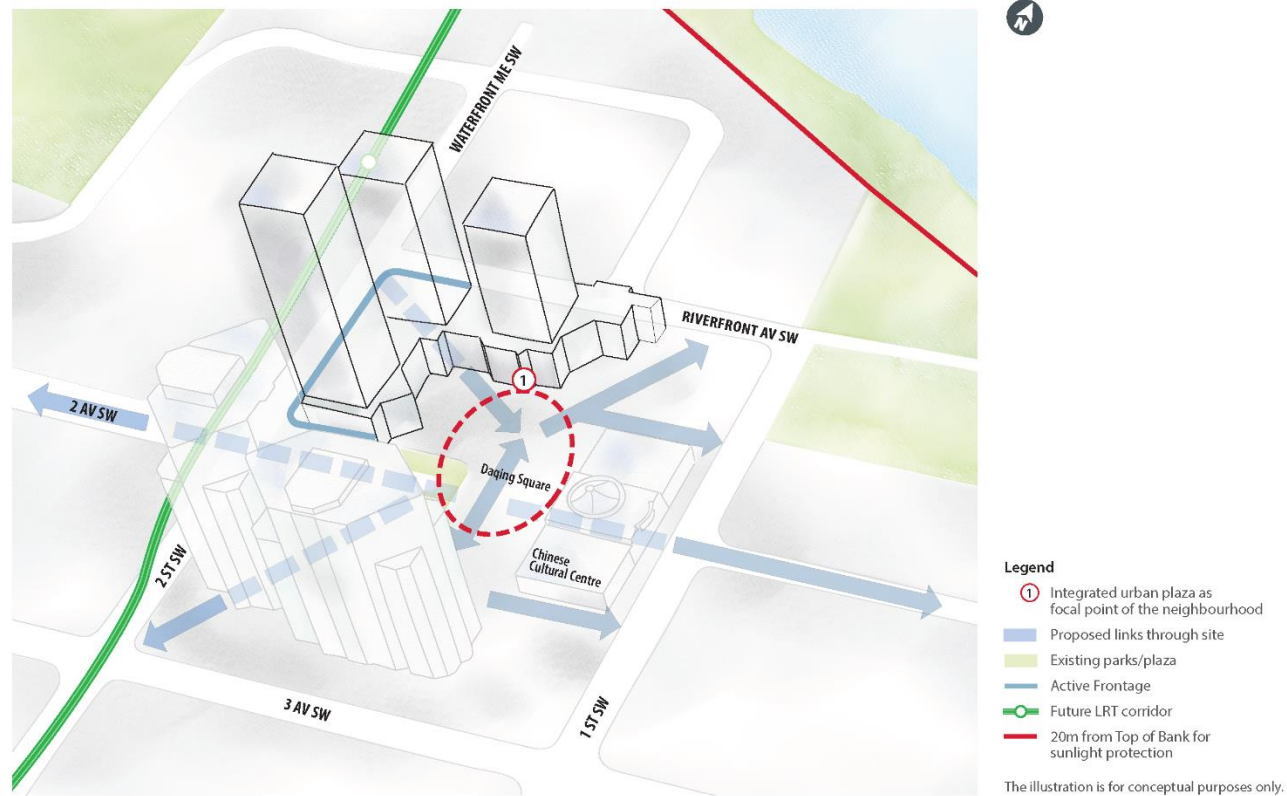

PROPOSED

BYLAW NUMBER 64P2022



Chinatown Cultural Plan

There are opportunities to address historical wrongs and injustices towards Calgary's Chinese community, and to recognize and share the important contributions of Chinese and Asian Canadians to Calgary and its culture. — **Action A1.1**

3.1.3.2 Comprehensive Planning Site 2: Harry Hays

Intent

Comprehensive Planning Site 2 (see Map 2, p. 22) focuses on the importance of extending 3 Avenue S.E. through the site (see Figure 7, p. 33). The intent is that this site will support residential uses supplemented by a range of commercial uses concentrated along 3 Avenue S.E. If redevelopment occurs, the intent of this site will be to support intensification through new buildings that frame the public streets and semi-private amenity space, improved connections for people traveling in the area and comfortable experiences for people walking and wheeling.

In addition to the general policies in Section 3.1.1, the following policies apply:

Policy

Land Use

- a. Land uses should be consistent with the intent for a comprehensive mixed-use development of up to 5.5 FAR, depending on the sunlight protection policies specified in this Plan.
- b. No standalone, single-use development should be allowed.
- c. Notwithstanding policy 3.1.1.e, for development within Comprehensive Planning Site 2 of 1.8 FAR or higher, 60 per cent of total gross floor area of all new buildings, at full build out, should be residential uses.

Site, Building and Landscape Design

- d. At the time of redevelopment, a comprehensive site plan should be provided and establish:
 - i. an internal pedestrian network;
 - ii. the location of buildings that focus on place-making; and,
 - iii. the incorporation of active uses, on-site open spaces, pedestrian passageways and pedestrian amenities.

- e. Redevelopment of the site should include a direct, at-grade pedestrian connection, in the form of a new retail street, established to extend 3 Avenue S.E. between 1 Street S.E. and Macleod Trail S.E.
- f. Buildings and site design elements should reflect the cultural and historic significance of the neighbourhood and reinforce Chinese/Asian cultural motifs. Particular focus should be placed on the 3 Avenue S.E. extension, riverfront interface and all street corners.
- g. Servicing and loading functions, and access to parkades and building mechanical systems such as ventilation screens, should be strategically located to minimize impact on the pedestrian realm and streetscape.
- h. Redevelopment of the site should include a balance of soft and hard landscaping (e.g. landscaped courtyards, urban plazas), and at a minimum, there should be no loss of local open space.

Site 2 history

The land on which the current Harry Hays building sits was expropriated by the federal government at the expense of the community. In 1974, 30 homes were demolished, which displaced 200 residents, who were once part of an established inter-generational community. This Plan attempts to recognize this history by reintroducing a residential base in this location and restoring the historic block structure.

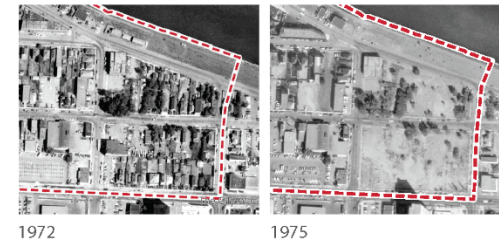

PROPOSED

BYLAW NUMBER 64P2022

Figure 7: Concept plan for comprehensive planning site 2

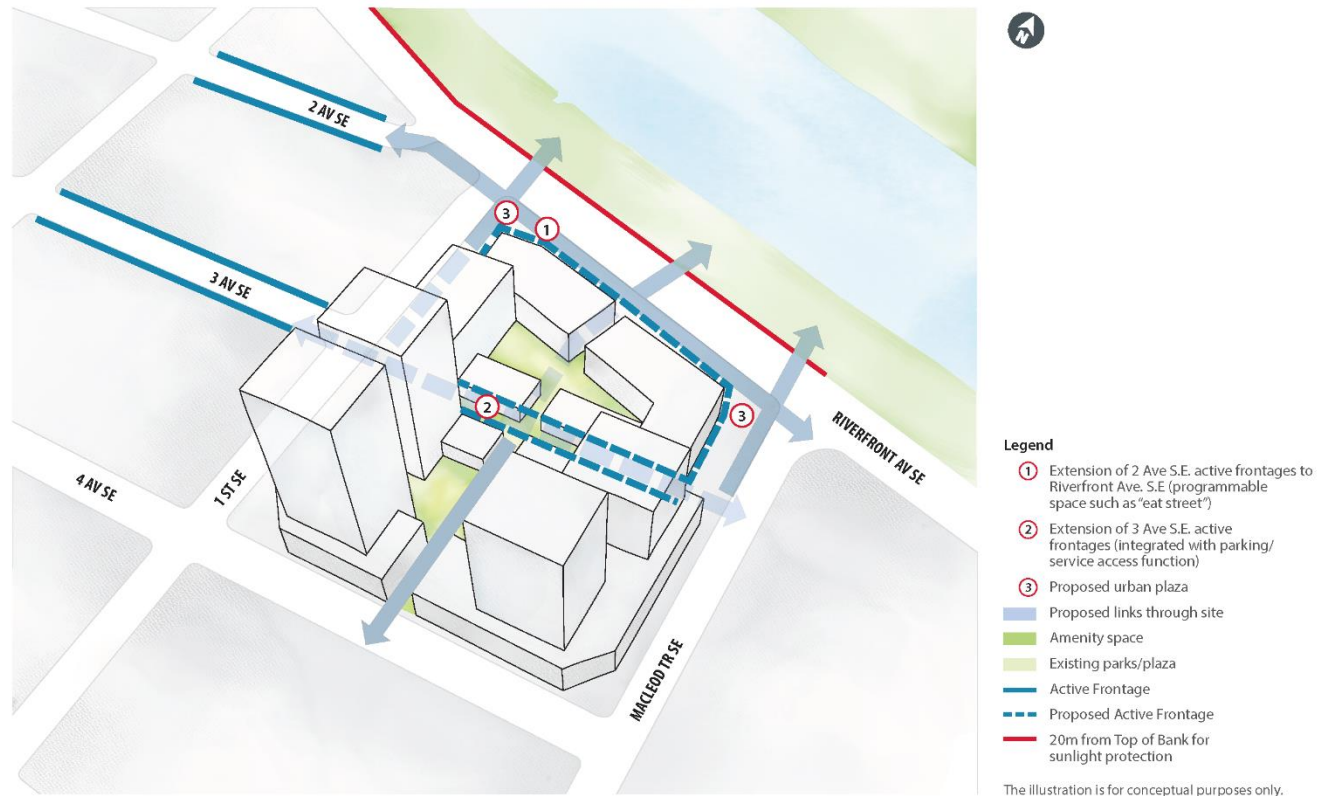

PROPOSED

3.2 Density

3.2.1 Density areas

Chinatown has been categorized into areas of different density depending on the purpose and character of the area and an area's ability to accommodate higher densities. The different areas are shown on Map 3 (p. 35) and are described below. Table 1 provides a summary of the density area policies.

Where applicable, land assembly and ownership have been taken into consideration. It is also recognized that there are land uses approved prior to the approval of this Plan, with density and bonus provisions that may be different than those in Section 3.2. The approving authority may approve Development Permits with alternatives to the density and bonus provisions contained in Section 3.2 of this Plan, if this is in accordance with a Direct Control District approved between 2016 December 1 and 2022 December 31.

Density shall be measured by Floor Area Ratio (FAR). FAR means the quotient of the gross floor area of a building divided by the gross site area.

Area A

Area A consists of the lands that are envisioned to be comprehensive development sites. Area A allows mixed-used development, which may be comprised of primarily residential development with commercial uses at grade creating active interfaces along Riverfront Avenue S.E. Area A supports single-use residential development and takes into consideration the shadowing of important public and open space areas.

Area B

Area B allows for existing developed areas to be re-developed as medium-profile, higher density mixed-use development, which offers residential and non-residential uses. Within Area B, single use buildings are discouraged. Re-development in Area B should be sensitive to and improve the identified character of the neighbourhood. The pedestrian interface is essential, with density and scale working to preserve and contribute to the street level experience.

Area C

Area C allows for the "non-river edges" of Chinatown to be re-developed as high-profile and high-density mixed-use development. Non-residential uses at-grade along identified active frontages and open spaces will enhance the pedestrian experience and establish links to landmarks and cultural destinations.

Table 1: Density concept

Area	Base Density (FAR)	Maximum Allowable Density (FAR)*1
A	3.0	5.5
B	6.5	7.5
C	7.0	9.0
C1	7.0	12.0
C2	3.0	12.0

* Site constraints and/or sunlight protection requirements may prevent maximum allowable density from being achieved.
1 The maximum allowable density listed in Table 1 may be exceeded by up to 10 per cent through a transfer of heritage density rights.



PROPOSED

BYLAW NUMBER 64P2022

Map 3: Density concept



*NOTES: Site constraints and or sunlight protection requirements may prevent maximum allowable densities from being achieved. The maximum densities listed in Table 1: Density concept (p. 34) may be exceeded by up to 10 per cent through a transfer of heritage density rights.

3.2.2 Density bonusing

3.2.2.1 Principles

A development can use density bonusing to obtain additional FAR, in exchange for providing public amenities, which support the increase of activity and larger population that higher density brings. Building density up instead of across an entire piece of land can create additional space at street level for amenities such as plazas, parks and other public spaces. Bonus density in Chinatown will be implemented through land use and development permits for the applicable parcel. It is at the discretion of the approving authority to evaluate the levels of benefit to the public and whether to allow the use of a density bonus provision in Chinatown.

- a. Base density (FAR) in Areas A, B and C may be exceeded through a land use amendment up to the maximum allowable density, as shown in Table 1 (p. 34), if the public benefit to Chinatown is demonstrated. Additional density beyond the base must be appropriate and supportable, considering the local site context and infrastructure constraints (see Utility infrastructure, p. 80).
- b. Bonus Density should be evaluated according to the following principles:
 - i. Density bonuses should be established only for items or features that provide a perpetual or enduring benefit to the neighbourhood in which the density will be accommodated;
 - ii. Unless otherwise specified through a development approval, a bonus earning item as listed in the Bonus Schedule for which additional gross floor area ratio has been achieved must be maintained on the parcel for so long as the development exists;
 - iii. Density bonuses should not be granted for elements of building or site design that can be achieved through other means;
 - iv. The amount of floor area granted through a bonus should be based on the additional monetary value added to the land as a result of the bonus and the cost to the developer of providing the bonus item;
 - v. Contributions and amenities achieved through bonuses are only a portion of what will be required to meet the needs of the neighbourhood as it grows; and,
 - vi. The provision of affordable housing should be provided prior to the use of any other bonus item. This Plan places a priority on the role and need for low-income or below-market affordable housing in Chinatown.
- c. Where necessary, legal agreements may be required to secure the long-term maintenance and operation of the features used to acquire bonus density.

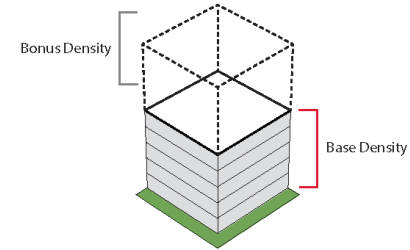

3.2.2.2 Bonus schedule

Development sites can be developed up to the base density without providing any bonus items. In order to develop above the base density and up to the maximum density, development should provide one or more bonus items in exchange for a defined amount of additional density. Subject to the discretion of the approving authority and the local context of the proposed development site, any combination of items in this schedule can be used to earn additional density, or through the land use amendment process, other amenity items could be approved. Details of each item are as follows:

a. Provision of affordable housing units

Description

Affordable housing units are defined as non-market housing units owned and operated by a housing provider approved by The City to provide non-market housing, provided within the proposed development.

Rationale

As allowable densities increase, so does the likelihood that higher density uses are redeveloped into affordable rental apartment buildings. Affordable housing unit provision within new development will help off-set the loss of existing affordable housing.

Eligibility

Any new development that can provide housing units within a proposed development in a number, location and of a design acceptable to The City or other genuine non-market housing provider recognized by The City, is eligible for this bonus.

Bonus Rate

The allowable bonus floor area will be based on the total construction cost of the units to a standard acceptable to The City. Cost estimates shall be prepared by a Professional Quantity Surveyor. For example, if the cost to the developer to provide 1,000 square metres of affordable housing units is \$500,000

and the average land value per square metre of buildable floor area for the area is \$270, then the amount of the bonus floor will be calculated as follows:

Total construction cost / (Average land value x 75%) + gross floor area of affordable housing units = Allowable Bonus Floor Area
 $\$500,000 / (\$270 \times 75\%) + 1,000 \text{ square metres} = 3,469 \text{ square metres}$

*Note: The average land value is discounted at a rate of 25 per cent to account for transactional costs associated with the provision and negotiation of the bonus.

b. Cash in lieu contribution for affordable housing units

Description:

Density may be granted for cash in lieu contributions towards affordable housing units. The funds may be used for the purchase of land or construction of affordable units in Chinatown.

Rationale:

As allowable densities increase, so does the likelihood that smaller, affordable rental apartment buildings will be redeveloped to higher-density uses. A fund that provides some affordable housing units elsewhere in the community helps off-set the loss of existing affordable housing, and promote housing equity.

Eligibility:

Upon creation of the Affordable Housing Fund, any development proposing to build above the base density allowed for the subject site is eligible to contribute to the Affordable Housing Fund. The contribution may be one component of a larger package of bonus items.

Bonus rate:

The amount of the contribution will be calculated at the time of development permit approval based on the average land value per square metre of buildable floor area as established by The City. For example, if the average land value for the area is equal to \$270 per square metre of buildable floor area, and a developer is proposing to build 1,000 m² of floor area above the base, then the amount of the contribution will be calculated as follows:

Average land value x Proposed amount of bonused floor area = Contribution

$\$270 \times 1,000 \text{ m}^2 = \$270,000$

This contribution amount represents what a developer would, on average, have to pay for the additional land within Chinatown necessary to support the additional floor area.

PROPOSED

BYLAW NUMBER 64P2022

c. Provision of indoor amenity space for community groups and support services

Description

Indoor amenity space for community groups and support services means floor area made available within a proposed development, in perpetuity to The City, in a form acceptable to The City for not-for-profit community purposes including but not limited to offices, meeting rooms, assembly spaces, recreation facilities, educational facilities, cultural facilities, daycares, Tong Houses and other social services. Cultural support space is an internal space that provides accommodation for one of the various branches of creative activity concerned with the production of imaginative designs, sounds or ideas. Cultural support space is intended for activities that do not require public accessibility, e.g. administration, rehearsal space, storage.

Rationale

Preserving cultural heritage is an important goal of the Plan. Cultural heritage is not limited to buildings, but extends to the many social and cultural groups who meet and gather in Chinatown. It gives its unique community and cultural support network. Therefore, it is important that new development recognize the importance of cultural groups and activities by allowing for space to accommodate a range of cultural activities within their sites.

Eligibility

The location, size and configuration of a physical space should be provided to the satisfaction of The City. The City shall secure the space in perpetuity through ownership or other acceptable means. The City will then contract the space to specific groups who can use the space. Developers are encouraged to develop their own relationships with possible groups or consult with The City on potential groups for community amenity space within their project.

Bonus Rate

The allowable bonus floor area will be based on the construction cost of the raw floor space and, where provided, any improvements to the space required by the proposed group using the space. It does not include operating costs. Cost estimates shall be prepared by a Professional Quantity Surveyor. For example, if the cost to the developer to provide the space is \$500,000 and the average land value per square metre of buildable floor area for the area is \$270, then the amount of the bonus floor area will be calculated as follows:

$$\text{Total construction cost} / (\text{Average land value} \times 75\%) = \text{Allowable Bonus Floor Area} \\ \$500,000 / (\$270 \times 75\%) = 2,469 \text{ m}^2$$

*Note: The average land value is discounted at a rate of 25 per cent to account for transactional costs associated with the provision and negotiation of the bonus.

d. Heritage designation

Description

A building or portions of a building are designated as a Municipal Historic Resource.

Rationale

As allowable density increases, the pressure to redevelop heritage sites also increases. To counterbalance this situation, incentives are required to conserve and re-use heritage resources.

Chinatown's heritage resources are important to both the neighbourhood and all of Calgary. They help sustain the living legacy of Chinatown and the Chinese community in Calgary and can unlock triple-bottom-line benefits recognized by the **Municipal Development Plan** and Calgary Heritage Strategy. Where heritage resources have been identified by the Inventory of Evaluated Historic Resources, they warrant protection and conservation wherever possible.

Eligibility

A heritage resource on a proposed development site must be designated as a Municipal Historic Resource. The upgrade to the structure shall be consistent with the Standards and Guidelines for the Conservation of Historic Places in Canada and to a degree that will allow for residential or commercial occupancy under the Alberta Building Code. Any cost estimates for the preservation, rehabilitation or restoration shall be submitted by the applicant and prepared by a Registered Architect with demonstrated experience in heritage conservation. Agreement on the cost estimates shall be determined through negotiations with the applicant and the Heritage Planning.

PROPOSED

BYLAW NUMBER 64P2022

Bonus Rate

The amount of additional floor area that may be earned through the preservation of heritage features is based on the overall cost of the preservation, rehabilitation, or restoration and any other related costs, depending on the specific circumstances of each building. Any bonus FAR will be determined through the land use and development permit approval process.

The floor area bonus will relate to the average land value per square metre of buildable floor area for the area. For example, if the total cost is determined to be \$500,000 and the average land value per square metre of buildable floor area for the area is \$270, then the amount of the bonus floor area will be calculated as follows:

$$\text{Total conservation cost} / (\text{Average land value} \times 75\%) = \$500,000 / (\$270 \times 75\%) = 2,469 \text{ m}^2$$

Any bonus floor area over and above the maximum allowable FAR for the subject property will reside with the property through an agreement acceptable to The City and may be transferred to other sites within the plan area.

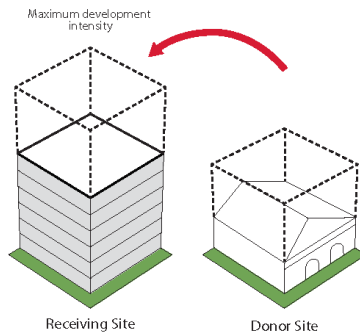

Land use and density

e. Heritage density transfer

Description

Heritage density transfer is the transfer of unconstructed gross floor area from a parcel designated by bylaw as a Municipal Historic Resource (donor site) to a development parcel (receiving site). The City establishes the policy and procedure for density transfer, which requires a Land Use Amendment for both source and receiver properties. The transaction for density is a market agreement between property owners, and The City is not involved in pricing or negotiations as to the payment terms and timeline(s) for the density.

Groups looking to acquire additional density engage directly with the owner of a designated (legally protected) heritage resource in the same plan area as their project site, and the two parties will reach a private agreement. The City has no responsibility to ensure payment or fulfillment of the conditions of the private agreement between the parties.

Rationale

As allowable density increases, the pressure to redevelop heritage sites also increases. To counterbalance this situation, incentives are required to conserve and re-use heritage resources.

Chinatown's heritage resources are important to both the neighbourhood and all of Calgary. They help sustain the living legacy of Chinatown and the Chinese community in Calgary and can unlock triple-bottom-line benefits recognized by the **Municipal Development Plan** and Calgary Heritage Strategy. Where the Inventory of Evaluated Historic Resources identifies heritage resources, they warrant protection and conservation wherever possible.

Eligibility

Unused density rights on an individual lot, created as a result of the formal designation of a building as a Municipal Historic Resource may be transferred to another development site or sites within Chinatown. At a minimum, the unused density shall be determined by subtracting the existing floor area from the total maximum allowable FAR as outlined in Table 1: Density concept.

Bonus Rate

Maximum allowable density as shown in Table 1: Density concept may be exceeded through a land use amendment on a receiving parcel by up to a maximum of 10 per cent for the purposes of accommodating a heritage density transfer. Additional density must be appropriate and supportable given the local site context.

Heritage density, calculated as gross floor area, may be transferred from a parcel that is legally protected as a Municipal Historic Resource (donor parcel) to a receiving parcel located within the plan area.

Both the donor parcel and the receiving parcel will require a Direct Control Land Use District to track the transfer of heritage density, as per standardized practice throughout Calgary's Greater Downtown.

Sites receiving heritage density transfers may exceed their maximum allowable floor area by up to 10 per cent, provided the additional 10 per cent is entirely the result of a heritage density transfer.

Chinatown Area Redevelopment Plan

PROPOSED

BYLAW NUMBER 64P2022

f. Contribution to the Chinatown Community Investment Fund (CCIF)

Description

The CCIF can be used for projects within the Chinatown neighbourhood related to public realm improvements, including but not limited to park acquisition, park and open spaces design, redevelopment or enhancement, streetscape design and improvements within rights-of-way, implementation of urban design strategies and public art on public land. Improvement fund scope and responsibilities to administer the spending from the fund are typically set through a policy plan, and updated over time.

Rationale

As development intensity increases, there is increased demand placed on public parks and open spaces, sidewalks, alleyways and roads. Additional and enhanced parks, open spaces and facilities will need to be provided in order to provide both existing and future residents with a quality public environment. Providing high quality walking and wheeling facilities will also minimize the potential number of automobile trips and maximize transit, pedestrian, and wheeling trips. Upgrading the public environment will make Chinatown a more attractive residential and business location and, as a result, will assist in allowing a vibrant Chinatown to reach its full potential.

Eligibility

Any development proposing to build above the base density allowed for the subject site is eligible to contribute to the CCIF. The contribution may be one component of a larger package of bonus items.

Bonus Rate

At the time of development permit approval, the contribution amount will be calculated based on the average land value per square metre of buildable floor area as established by The City.

For example, if the average land value for the area is equal to \$270 per square metre of buildable floor area, and a developer is proposing to build 1,000 square metres of floor area above the base, then the amount of the contribution will be calculated as follows:

Average land value x Proposed amount of bonused floor area = Contribution
 $\$270 \times 1,000 \text{ m}^2 = \$270,000$.

This contribution amount represents what a developer would, on average, have to pay for the additional land within Chinatown necessary to support the additional floor area.

PROPOSED

BYLAW NUMBER 64P2022



Chinatown Cultural Plan

New funding and incentive tools should be adopted that ensure heritage revitalization does not lead to the displacement of — but instead to new opportunities for — cultural groups, programs and activities. — **Action E2.1**

3.2.2.3 Administration of the Chinatown Community Investment Fund

The CCIF is established by Council and administered by a Committee with a Terms of Reference and membership approved by Council. The Committee should have a core membership with representation from within the Chinatown community who have an interest such as a Business Improvement Area and Community Association.

3.2.2.4 Establishing the average land value per square metre of buildable floor area

The average land value per square metre of buildable floor area shall be adjusted annually based on the yearly Statistics Canada Consumer Price Index (CPI) for Alberta and with a base average land value of \$270 starting in the year 2023. For example, if the year is 2025 with a CPI change of 3.7% for the year 2024 and 4.1% for the year 2025, then the adjusted average land value will be calculated as follows:

Base average land value (or adjusted average land value from previous year) x Percentage change in CPI for all items = Adjusted land value for current year.

$\$270 \times 3.7\% = \279.99 for the year 2024

$\$279.99 \times 4.1\% = \291.47 for the year 2025



3.3 General policy

General policies apply to all land in the plan area and all land use classifications located within the plan area (see Map 2, p. 22).

3.3.1 Climate change mitigation and adaptation

In addition to the climate policies in this section, guidance and policies in the Municipal Development Plan, Calgary Climate Strategy – Pathways to 2050 and Calgary’s Greater Downtown Plan should be reviewed for direction on additional climate mitigation and adaptation direction.

Climate policies included in this Plan are divided into several key themes in alignment with the Calgary Climate Strategy — Net Zero Homes and Buildings, Zero Carbon Energy Transition and Zero Carbon Neighbourhoods (mitigation) and People, Built infrastructure, Natural infrastructure and Water (adaptation).

3.3.1.1 Climate mitigation

Policy

Net zero homes and buildings

- a. Promote retrofit and renovation projects that improve long term energy use and performance in buildings.
- b. Encourage net zero and/or net zero-ready development.
- c. Net zero-ready development should provide a plan to achieve net zero by 2050.
- d. New development, renovation and retrofit projects should use climate mitigation building features, technologies, and operational approaches. This may include, but is not limited to:
 - i. lowering energy consumption beyond minimum energy code requirements by using high performance mechanical systems and building envelope wall-assemblies;
 - ii. participating in measuring and disclosing energy performance through the City’s Commercial and Institutional Building Energy Benchmarking program; and,
 - iii. lowering embodied emissions and waste production by re-purposing existing buildings and reusing building materials.



Zero carbon energy transition

- e. A Low Carbon Energy Supply Feasibility Study, conducted by qualified professionals, should be submitted when new or renovation projects are not designed to a net zero or net zero-ready standard.
- f. New development, renovation and retrofits should reduce greenhouse gas emissions by integrating on-site renewable energy generation and other alternative energy sources, including but not limited to solar photovoltaic, geothermal and district heating.
- g. Where a Low Carbon Energy Supply Feasibility Study has been submitted, feasible sustainable building features and technologies should be incorporated into development.

Zero carbon neighbourhoods

- h. New development, major renovation and retrofit projects should include appropriately scaled:
 - i. bicycle and end-of-trip facilities;
 - ii. solar collector canopies in new and existing at-grade parking areas; and,
 - iii. electric vehicle (EV) charging infrastructure. Where vehicle charging infrastructure may not be warranted, EV capable charging stalls should be provided.

3.3.1.2 Climate adaptation

Policy

People

- a. Encourage the provision of shading and cooling structures on public and private lands, especially at transit stops and stations, heavily paved areas, and areas with lower tree canopy coverage.
- b. Encourage the provision of structures to shade and cool in development bounded by 2 Avenue S.E. and 4 Avenue S.E. and Centre Street S. and Macleod Trail S.E., where the temperatures are higher than other parts of the neighbourhood (source: Urban Heat Island Map).

Built infrastructure

- c. New development, major renovation and retrofit projects should include:
 - i. climate resilient features such as cooling systems (e.g. building canopies, air-source heat pumps, air conditioning), green roofs, climate resilient building materials, high efficiency insulation and/ or permeable native landscaping;
 - ii. food production opportunities such as rooftop gardens or edible landscaping; and,
 - iii. back-up power generation that can function during periods of power loss — where possible from renewable sources.
- d. New development, major renovation, and retrofit projects should consider the use of semi-permeable pavements where possible.

Natural infrastructure

- e. New development, major renovation and retrofit projects should reduce the amount of impermeable surfaces, and exceed minimum landscaping requirements for trees and soft surfaced areas to limit impacts associated with extreme heat events and stormwater flooding.
- f. Prioritize the protection and retention of healthy trees on public and private lands. Trees that cannot be kept during redevelopment should be replaced in a suitable location.
- g. Vegetation and trees chosen for public areas, parks and private development should be diverse native species that are tolerant to periods of drought, suitable for extreme weather conditions, and appropriate for soil volume and composition.

Water

- h. New development, major renovation and retrofit projects should:
 - i. minimize water demand; and,
 - ii. use sustainable water sources to supplement landscaping irrigation on public or private lands.
- i. Public spaces, like parks and gathering areas, should be designed to include drinking fountains and washrooms.

3.3.2 Sunlight protection

Sunlight protection areas are shown on Map 3 (p. 35). Policy related to sunlight protection may impact site design and building size for any new development.

Policy

- a. The following sunlight protection areas shall not be shadowed further by development as measured on September 21, at the times and locations given for each area, than were already existing on the date the development permit was applied for:
 - i. the Riverbank as measured 20.0 metres wide throughout abutting the top of the south bank of the Bow River, from 10:00 a.m. to 4:00 p.m., Mountain Daylight Time;
 - ii. Sien Lok Park north of Riverfront Avenue S.W. between Centre Street S. and 1 Street S.W., from 10:00 a.m. to 4:00 p.m. Mountain Daylight Time; and,
 - iii. Sien Lok Park south of Riverfront Avenue S.W. between Centre Street S. and 1 Street S.W., from 12:00 p.m. to 2:00 p.m. Mountain Daylight Time.
- b. Notwithstanding policy 3.3.2.a of this Plan, development in the sunlight policy exception area as shown on Map 3 (p.35) may cast shadow into Sien Lok Park between 12:00 p.m. to 2:00 p.m. Mountain Daylight Time as measured on September 21, provided the shadow into the park is comparable to that of existing development within the block.
- c. Notwithstanding policy 3.3.2.a of this Plan, the panhandle area of Sien Lok Park, as shown on Map 3 (p.35), may be shadowed between 1:30 p.m. and 4:00 p.m. Mountain Daylight Time as measured on September 21.



PROPOSED

BYLAW NUMBER 64P2022



Chinatown Cultural Plan

Chinatown currently does not have a gateway. Residents, businesses and artists could come together to imagine innovative, never-before-seen ways to visually mark the entry points to this special community. — **Action E3.2**

The entrance into Chinatown from Centre Street Bridge should become a visual experience with an abundance of neon, light art and projections on the façades and rooftops. — **Theme B Map of Aspirations (E)**

New fun and instagrammable spots will interest people to stay longer and explore unfamiliar areas of Chinatown. These spots can include places to sit, chat, learn, experience and take lots of selfies. — **Theme C Map of Aspirations (E)**

3.3.3 Gateways, landmarks and view corridors

Public spaces in front of buildings and the buildings themselves should be designed to highlight and promote the gateways, landmarks and view corridors as shown on Figure 8 (p. 46). The identified sites, buildings, structures, parks and escarpment areas will provide context and character for both public improvement and development projects in Chinatown.

Policy

- a. Development within sites at gateway locations, as shown in Figure 8 (p. 46), should:
 - i. be designed as culturally sensitive, contemporary landmark buildings with exceptional architectural merits;
 - ii. be designed with highly original and innovative massing, orientation and façade design, and durable materials or technology that have a positive effect on the public realm and spaces.
 - iii. demonstrate how the use of public art, architecture and other design elements offer a visible and physical gateway to Chinatown.
- b. Public and/or publicly accessible small plazas, patios, gardens and public seating should be provided at strategic locations along the view corridors, as shown in Figure 8 (p. 46), for people walking and wheeling to enjoy.
- c. Public realm design at all public transit stations and stops, along view corridors, as shown in Figure 8 (p. 46), should receive special treatment to ensure accessibility, natural surveillance, vibrancy and character.

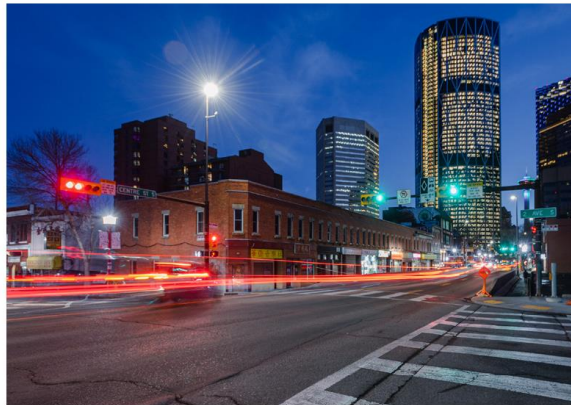
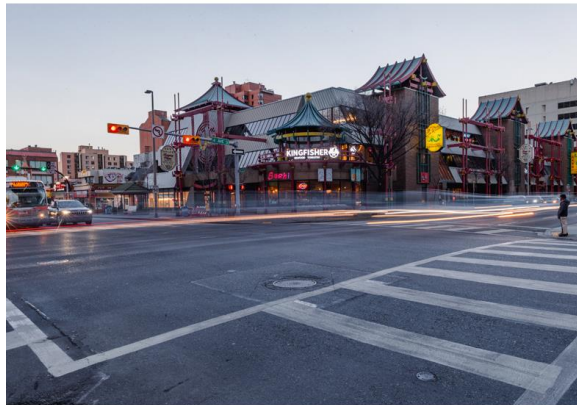

45

Land use and density

Chinatown Area Redevelopment Plan

PROPOSED

BYLAW NUMBER 64P2022

Figure 8: Gateways, landmarks and view corridors

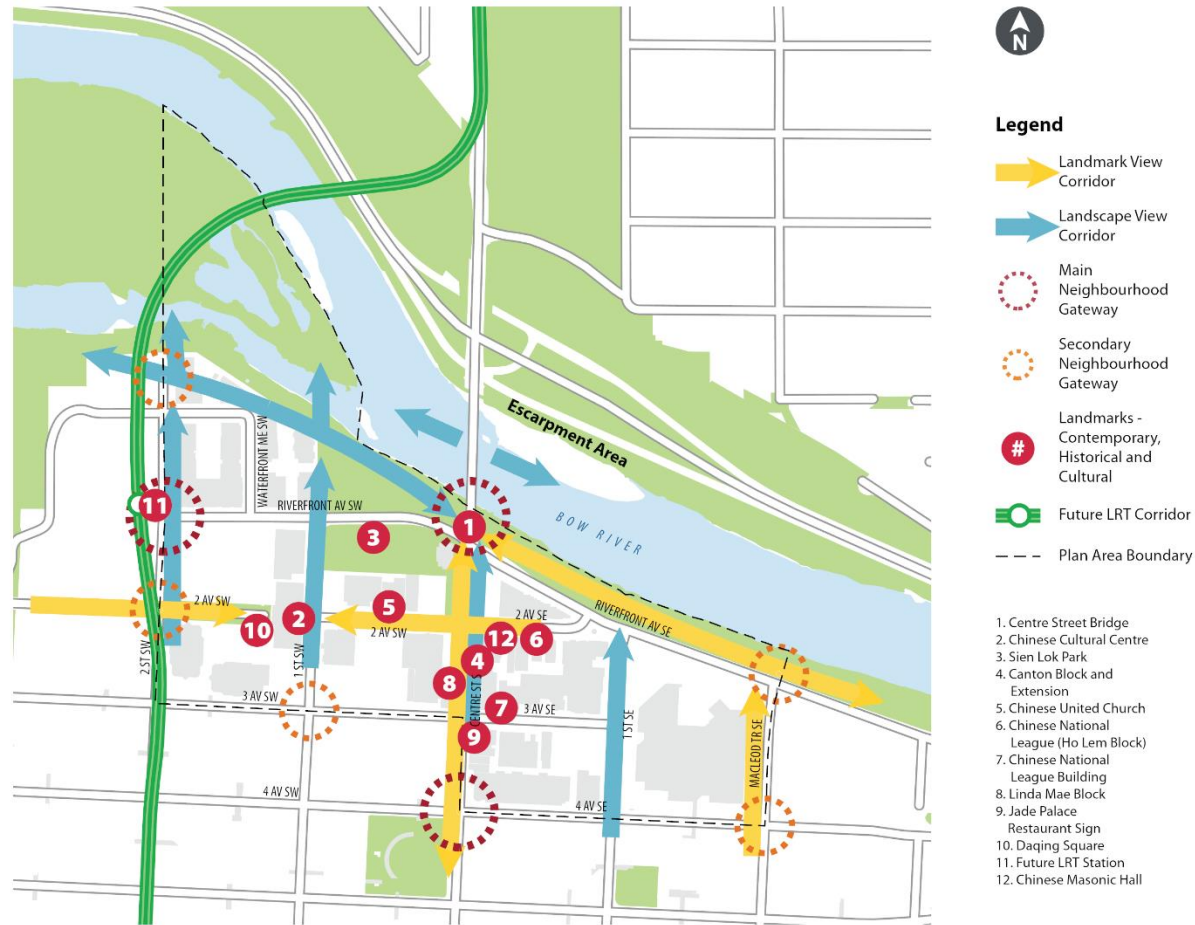

PROPOSED

BYLAW NUMBER 64P2022

3.3.4 Plus 15 network and protected views

The Plus 15 network is a valuable part of the mobility network in Calgary's Downtown Core, which extends into Chinatown. It provides safe, weather-protected, and attractive connections to destinations as well as utilizes this connective space to create unique experiences for people. For guidance related to future development, operations and management of the long-term Plus 15 network, please refer to the City's Plus 15 Policy.

Policy

- a. Look for opportunities to improve the Plus 15 network, while meeting the requirements defined in the Plus 15 Policy.
- b. All north views, toward the Bow River escarpment areas, along the streets between 2 Street S.W. and Macleod Trail S.E., should be protected and enhanced. Any obstructions of the views are not supported within a minimum distance of two blocks from the riverfront promenade. Dramatic escarpment views are opportunities to tell Indigenous perspectives and stories about the landscape (i.e. importance of the escarpment landscapes for buffalo hunting).
- c. When on Centre Street S., views of the Centre Street Bridge and Calgary Tower should be protected and enhanced, at a minimum distance of two blocks from each landmark structure.
- d. When on 2 Avenue S.W., views of the Calgary Chinese Cultural Centre should be preserved by limiting new Plus 15 bridges across 2 Avenue S.W. at a minimum distance of one block west of the landmark structure.
- e. Public access from ground level to the Plus 15 network, with visual transparency, should be provided to take advantage of landmark and landscape views from the Plus 15 bridges.
- f. Future Plus 15 bridge crossings should be designed with cultural reference (see Section 4.1.3, p. 56).



47

Land use and density



Chinatown Area Redevelopment Plan

PROPOSED

BYLAW NUMBER 64P2022



Chinatown Cultural Plan

New housing is a priority for those already connected to Chinatown, such as seniors looking to be near cultural services. — **Action D1.2**

Multigenerational housing options are desired, such as 3+ bedroom units and lock-off suites, and spaces for young and old to mix. — **Action D1.1**

Innovative housing concepts can redefine multi-generational living, with elderly-friendly units designed for seniors, while the (grand)children live separately in the same estate or nearby. — **Theme D Map of Aspirations (B)**

3.3.5 Housing

This Plan aims to ensure a wide variety and mix of housing types and unit sizes to accommodate different household types and lifestyles that encourage social diversity (as outlined by Canada Mortgage and Housing Corporation's housing continuum).

Having access to safe and stable culturally-appropriate homes in Chinatown provides many benefits:

- Helps create an inclusive, healthy, prosperous and safe neighbourhood.
- Adds diversity by attracting young adults and families into the neighbourhood.
- Provides chances for residents to find and keep jobs; learn and build skills; and, be active community participants.
- Keeps vulnerable residents off the streets and reduces demand and pressure on emergency services, hospitals and the justice system.
- Boosts the local economy through:
 - construction-related jobs;
 - increased purchasing power of residents; and,
 - attracting employers with the promise of a more stable workforce.

In addition to the policies included in Sections 3.1, 3.2, 4.2 and in Chapter 4: Urban Design in the Centre City Guidebook, MDP Vol 2, Part 2, the following policies apply:

Policy

- a. Explore opportunities to include affordable housing units in residential development.
- b. New development should:
 - i. contribute to age-friendly housing and support multigenerational living through innovative housing design such as units with lock-off suites, two primary bedrooms and accessible washrooms; and,
 - ii. support the diversification of the housing stock to suit the needs of larger families by encouraging multi-unit housing development to offer units with two and three or more bedrooms.
- c. Where municipal land is available, explore the coordination of non-profit land sales for affordable housing and dispose according to City policy.
- d. Encourage the co-location of affordable housing units within civic projects.
- e. Support the intensification and retention of existing affordable housing development to ensure no net loss of number of units.
- f. Explore opportunities for partnerships between public, private and non-profit organizations to help integrate affordable housing in locations supported by mobility choices, public amenities and access to services.
- g. Support deep energy retrofits within existing affordable housing development to reduce emissions and energy bills.
- h. Explore opportunities for new affordable housing to be designed to net zero energy standards.

Refer to the Corporate Affordable Housing Strategy for the most recent definition of affordable housing.

PROPOSED

BYLAW NUMBER 64P2022



4

Character areas

特色區域

特色区域

PROPOSED

4.1 History, design and character

Chinatown’s look, feel and experience are influenced by the buildings, streets and places valued by the community. When the most important parts of Chinatown’s look and feel, and sense of place are understood and fit together, they can inspire pride in the city and attract investment to the neighbourhood.

The Plan acknowledges that Chinatown is a culturally important historic neighbourhood, but as a result of historical build-out, the development and appearance of Chinatown can significantly vary from one area to another. In recognition of this context, and to support the diverse range of assets and opportunities in Chinatown, three character areas (see Map 4, p. 51) are presented within the plan boundary: Heritage Core; Cultural Core; and, Edge. Each character area has accompanying policies that guide urban design and heritage conservation (see Section 4.2).

People using this Plan must reference relevant policies in this Plan as well as Chapter 4: Urban Design in the Centre City Guidebook, MDP Vol 2, Part 2.



Chinatown Area Redevelopment Plan



Chinatown Cultural Plan

A building could be converted into a place where people of mixed ages, backgrounds and skills can learn, create and activate Chinatown together: in the building, on the streets and in the community at large. — **Action A2.4**

Cultural and language barriers have kept much of Chinatown’s heritage ‘hidden’ to most. An opportunity is to reveal these histories through info signs, public art, open houses, social media and cultural resource maps. — **Action E2.3**

The depth of Chinatown’s legacy is worthy of a physical place where the histories are made accessible for everyone to enjoy. Perhaps the National League Hall is a suitable place. — **Theme D Map of Aspirations (B)**

PROPOSED

BYLAW NUMBER 64P2022

Map 4: Character areas

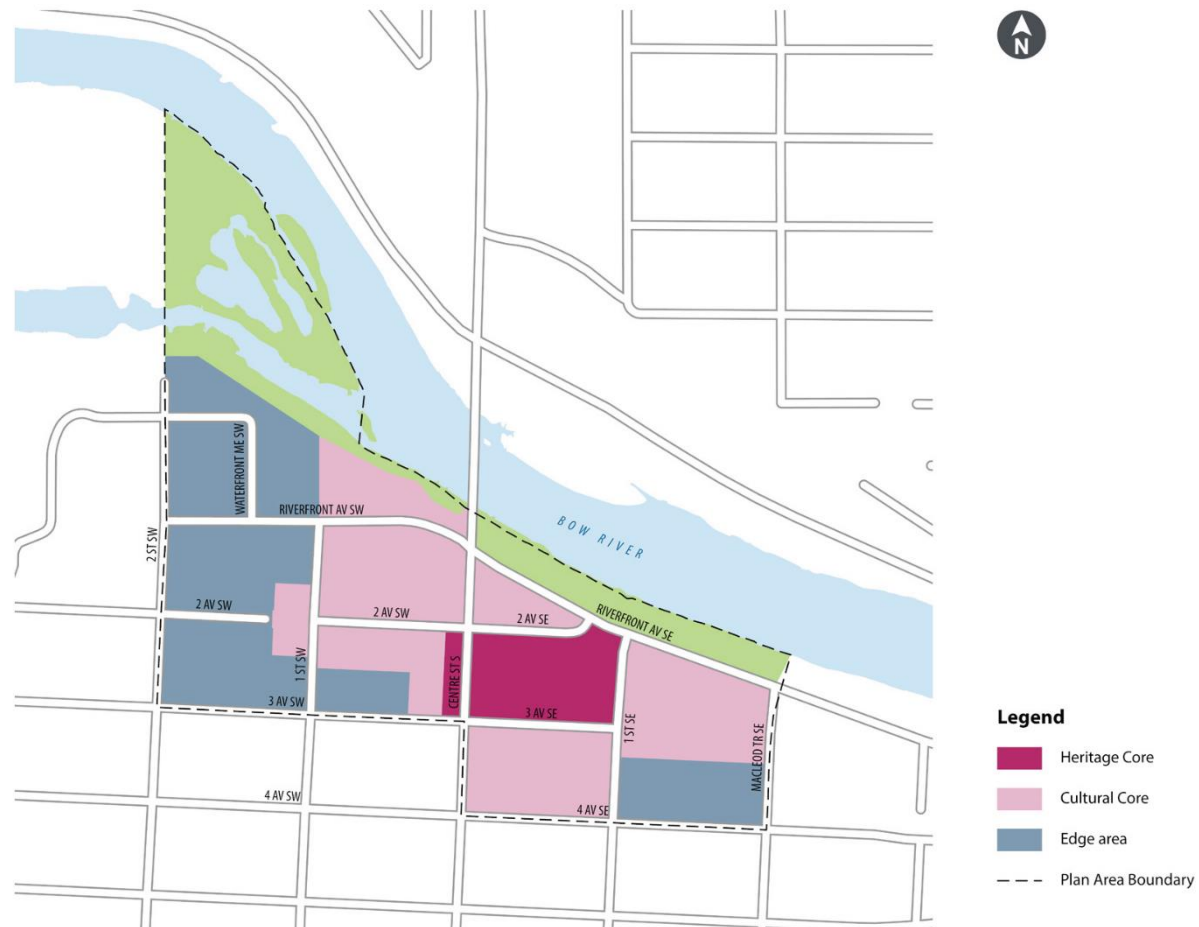

PROPOSED

BYLAW NUMBER 64P2022

Figure 9: Focus and intent of each character area

Heritage Core

The Heritage Core prioritizes conserving and enhancing a small, but important group of heritage resources. Policy focuses on adding, altering and adapting culture based on preserving heritage.



Cultural Core

The Cultural Core focuses on places for gathering and expressing culture that help define the Chinatown character. Policy focuses on making sure redevelopment is sensitive to the existing scale and parcel pattern.



Edge area

The Edge area focuses on reinforcing neighbourhood character by applying an understanding of the heritage, character and context of Chinatown through contextual new development.



4.1.1 History of Chinatown's design and character

Unique physical design and character

Chinatown is a unique cultural neighbourhood in Calgary. Its physical form and character have been shaped by cultural, political and economic influences throughout many periods of development and important historic events. Today's Chinatown is the third and official location of a Chinatown area in Calgary's history. It is anchored by the Canton Block — the first land owned by Chinese immigrants in Calgary. Chinatown contains buildings and sites with a mixture of architectural styles, designs, sizes and ages of construction. The overall cultural and community influence unifies this mixed urban environment, with a small but highly important collection of identified heritage resources. The area was then supported by the creation of neighbourhood design standards in the 1970s and 1980s, which intended to conserve and revitalize Chinatown as a visually unique area.

The oldest intact structures in Chinatown are early twentieth century commercial buildings, which are designed in Edwardian and Early-Modern architectural styles. These designs were broadly popular in Calgary at their time of construction. The exterior of these buildings are similar to commercial structures in other neighbourhoods from the same time period, because they reflect the pressure towards cultural assimilation. These buildings showed their unique cultural design through Chinese signage and interior layouts, which supported Chinese-specific business and cultural institutions.

Decorative elements

Chinatown's architecture after World War II reflected a resilient and adaptive approach to racist stereotypes of Chinese culture that remained constant outside of the community. In this period, design moved away from the modesty of earlier architecture and instead, displayed more obvious Chinese culture references to attract non-Chinese visitors to Chinatown. Ornate and sometimes-flamboyant decorative elements were included in new development and added to existing buildings, including large neon signage, and cladding elements, which suggested a generalized sense of Chinese design and construction.

Character motifs established

The transition from the emerging visual character of the post-war period to Chinatown's present-day appearance was significantly shaped by the **Calgary Chinatown Design Brief** (1976). This document played a major role in a 'revitalization period' for Chinatown. It was an important influence to the neighbourhood's present-day layout and appearance. Amenities like the Calgary Chinese Cultural Centre, Sien Lok Park, and increased seniors' housing have their roots in the **Calgary Chinatown Design Brief** (1976), which attempted to balance the needs of residents with Chinatown's role as a 'cultural home' for the now-broader Chinese community in Calgary. The **Calgary Chinatown Design Brief** (1976) and subsequent **Chinatown Area Redevelopment Plan** (1986) also established visual standards for the types of 'character motifs' that are now seen in Chinatown, such as pagoda-style roof caps and patterned metal fencing, and the decorative use of Chinese characters and symbols.

Planning approach to highlight Chinatown's diverse history

The planning approach to heritage conservation and urban design in this chapter was created to recognize the unique development context outlined in this section, and its impacts on Chinatown's present-day urban form. The identified character areas provide policies (see Section 4.2, p. 57) for specific locations to guide architectural and cultural expression that seek to highlight Chinatown's diverse history, rather than adopt one standard for the entire community. It means future redevelopment can respond to the variety of heritage and cultural resources across multiple stages of growth and change, while maintaining an overall look and feel that is identifiable as Chinatown.

Chinatown Historical Context Paper

The **Chinatown Historical Context Paper**, commissioned by The City of Calgary in 2019, informs this summary. Historical context papers are reference documents created to promote greater understanding of a community's development, including major historical events, people, institutions and structures. The Chinatown Historical Context Paper draws on a variety of historic and current sources. It includes generous contributions from members of the community.

The **Chinatown Historical Context Paper** may provide valuable information, but should be used as a starting point for further research, engagement and exploration — particularly involving sources and voices directly tied to Calgary's Chinatown.

4.1.2 How to use design guidance

Qualitative design guidance

Design guidance in this chapter is more qualitative in nature. It is based on six urban design elements (see Figure 10). When used together with the land use, density and general policies in Chapter 3, it should result in the desired outcome of preserving and enhancing the character of Chinatown.

New development and renovation projects should consider more than just individual buildings. They need to fit into the Chinatown-specific urban context and the identified character areas (see Map 4, p. 51). Project design should reflect the surrounding environment with good public realm, site, and architecture design that meets the design expectations set out in this chapter.

The Urban design elements framework (see Figure 10) provides direction on high-level design, clarifies expectations for design, and sets the criteria to evaluate the quality of design for public and private spaces and buildings.

Figure 10: Urban design elements framework

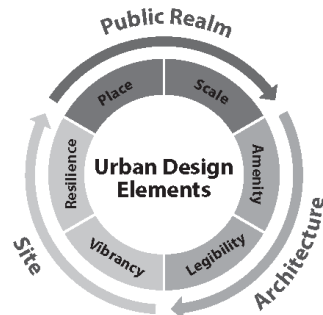

Chinatown Area Redevelopment Plan

Cultural reference and design compatibility

Cultural reference is introduced in this Plan as an important way to boost the “look and feel” of Chinatown. It promotes a visual connection between the building and local character through character defining elements, or cultural expressions (such as culturally appropriate design, Chinese/Asian motifs and signage).

This chapter does not advise specific architectural styles. It does not encourage direct imitation of the past or departure from the existing context. Instead, it introduces the idea of designing buildings and spaces that fit the local character, architectural materials, and the local activity at the street level. The building design should contribute to the overall quality, look and feel of this cultural neighbourhood.

The strength of cultural reference and the level of design that fits with its surroundings should be directly related to the location of the project. At a minimum, the level of cultural reference should be comparable to existing local examples in each character area, as outlined in Section 4.1.3 (p. 55/56), in terms of the location, type, amount and finer details of the character defining elements.

As a general guidance, the following should apply:

- **Heritage Core area:** moderate cultural reference and high design compatibility
- **Cultural Core area:** high cultural reference and moderate to high design compatibility
- **Edge area:** moderate cultural reference and moderate design compatibility

For example, if a project is located in the Cultural Core, it is expected the project will include a high level of cultural reference with moderate to high design compatibility. Reflected in the built form, this includes two aspects:

1. offer a stimulating design for people to experience that relates to Chinese/Asian cultures, such as engaging indoor and outdoor activities generated by ground floor activities and uses. Other examples are unique designs of storefronts, building fronts, signage, lighting, public art and other elements in public spaces. In this case, culturally inspired design should be applied to many locations of the building, site, and public space, which results in many layers of elements that define character (see Section 4.1.3, p. 55/56); and,
2. base the design on the location of the project and its surrounding urban design context, such as street wall height, storefront width, setbacks, cornice line, materials or other featured design elements in public spaces.

Design proposal equivalencies

Although the design policies will be used as a benchmark for design outcomes, not all guidance applies to all proposals. A project may be considered if it meets the intent of the Plan while demonstrating a different approach toward achieving the overall objectives of The Plan.

Character areas

4.1.3 Character defining elements and motifs

The use of distinctive architectural motifs and design elements adds to the visual characteristics that make Chinatown special. It allows people the chance to experience the Chinese/Asian culture exhibited in Calgary's Chinatown. The **Chinatown Cultural Plan** identifies successful cultural motifs that contribute to Chinatown's sense of place. Authentic references to, or interpretations of Chinese/Asian architectural motifs in new development, renovation and public improvement projects can be an important way to promote and support the culture and identity of the community.

Architectural motifs are decorative elements and design details that are repeated across multiple buildings, scales and eras to create a broader identity. In the case of Chinatown, a language of motifs has developed based on traditional Chinese construction, design and culture. These motifs can be structural — roof lines, columns, beams, door lintels, brackets, etc. — ornamental, — window screens, building corner detailing, tile wall finishes, etc. — or in some cases combine both types as assessed and confirmed by the Chinatown Sense of Place Survey (Alaniz Uribe, 2021)¹.

A variety of perspectives exist on the authenticity, appropriateness and relevance of certain forms of cultural motifs in Chinatown. One architectural motif may hold many different meanings to people and can represent positive and negative meanings. Using a diverse range of cultural motifs is supported with opportunity for honouring the historic appearance of Chinatown and innovative Chinese/Asian cultural expressions.

To help define the neighbourhood's existing visual character and identity, a list of design elements used in Calgary's Chinatown is shown on page 56. These design themes provide a basis for what can fit with the "look and feel" of Chinatown but do not represent the total range of possibilities for cultural expression. A given motif or design element will not be appropriate for all contexts or areas. Development and redevelopment projects will need to consult the community at development permit stage to help ensure representation of the intended cultural messaging is appropriate and authentic.



Structural: rooflines, columns, beams brackets

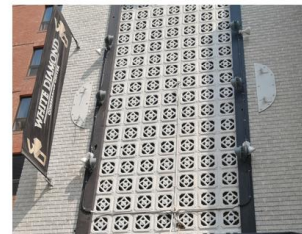

Ornamental: detailing, railings, screens, wall finishes, colours

¹ Chinatown Sense of Place Survey, lead by Francisco Alaniz Uribe, University of Calgary, School of Architecture, Planning and Landscape, The Urban Lab, September 10, 2021

PROPOSED

BYLAW NUMBER 64P2022

The design of all new public spaces, sites and architecture in Chinatown should focus on the quality of the experience and focus on improving the relationship between buildings and public spaces, while also including the use of distinctive Calgary Chinese/Asian architectural motifs and design elements.

Public realm

- Encourage Chinese inspired public spaces.
- Expand pedestrian spaces for street vendors and programming.
- Use string lanterns to strengthen the “look and feel” of the area as a whole.
- Install traditionally inspired pedestrian amenities such as Chinese banners, streetlights, kiosks/pavilions, transit shelters, artistic urban furniture, movable planters, decorative tree grates, tree seats, outdoor exercise equipment, playground, painted utility boxes, etc.
- Install and enhance new traditionally inspired gateway or landmark enhancement features.

Site

- Unique signage with Chinese characters.
- Enhance public gathering places with patios, distinctive landscaping and furniture which reflects traditional Asian influences.
- Position buildings towards courtyards, streets with active frontages, parks and plazas.
- Public art and interpretive features.
- Pedestrian focused feature lighting.
- Traditional inspired paving techniques and materials.
- Featured fences and railings.
- Decorative installations along railings, blank walls and pavements.

Architecture:

- Vertical mixed-use — retail at-grade, Tong Houses on second level and residential units on upper levels.
- Narrow storefronts with creative architectural motif integration on the building facades (e.g. pagoda style roof details, traditional symbols and patterns, wooden brackets, lanterns, medallions, balustrades, cloth awnings).
- Ground level or split-level commercial entrances with underground commercial uses.
- Highlight entrances with culturally-distinct signage, display windows, lighting and art.
- Organize clusters of businesses around an internal courtyard/alley, or a multi-level atrium.
- Windows at ground level that open.
- Unique window configurations and mullion patterns, projections and insets.
- Murals on walls, alleyways and garage doors.
- Special design treatments on building rooflines (cornices, parapets, and eaves).
- Traditional architectural materials such as wood, ceramic tiles, bricks, masonry and stones.
- Emphasis on traditional Chinese/Asian colour preferences (red, yellow, green, patterned).



Chinatown Area Redevelopment Plan

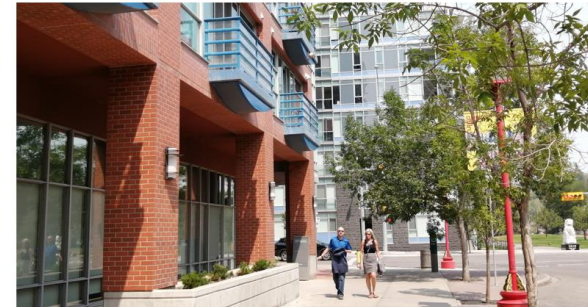

Character areas



Chinatown Cultural Plan

Rooftops, façades, awnings, bus stops, shutters and utility boxes; almost anything can become a canvas for designs that reflect Chinatown's culture. Policy relaxations and art budgets are needed to support this. — **Action B2.4**

4.2 Character areas policy

4.2.1 General

The following policies provide direction for the three character areas in Chinatown including Heritage Core, Cultural Core and Edge area (see Map 4, p. 51).

Policy

Site design

- a. Areas negatively impacted by vehicular entrances, parking ramps, service areas, utilities, blank walls, stairs and ramps at grade separated areas should incorporate character defining elements (see Section 4.1.3, p. 55/56) through creative use of design strategies such as enclosures, architectural screening, artistic railings, featured quality finishes, murals, sensitive lighting and a balance of soft and hard landscaping.

Building frontages

- b. For colonnades and canopies along building frontages (see Figure 11), the following should apply:
 - i. colonnades should only be used in sunny locations along streets identified as Active Frontage on Map 2 (p. 22);
 - ii. north-facing colonnades are discouraged in favour of transparent canopies;
 - iii. colonnades should provide transparency at the internal façade of any colonnade using large windows to allow indirect sunlight into the building interiors;
 - iv. any colonnade area should provide the preferred height-to-width ratio of 2:1;
 - v. canopy heights should be kept to a maximum of 3.0 metres to protect pedestrians effectively from weather; and,
 - vi. the use of transparent and visually light canopies should be encouraged for sunlight penetration and passive surveillance.

Figure 11: Colonnades

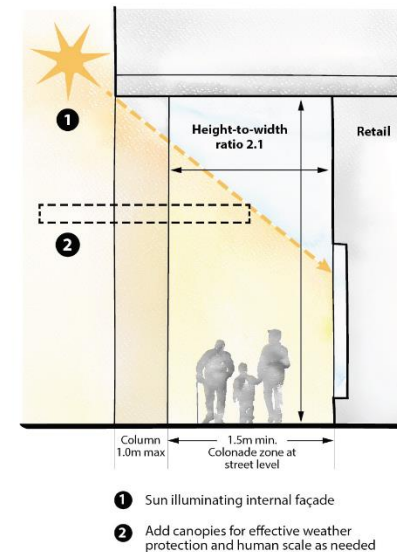

The illustration is for conceptual purposes only.

PROPOSED

BYLAW NUMBER 64P2022

Building massing

- c. Each floor of a building containing residential uses and located above 12 storeys in height should not exceed a maximum floor plate area of 750.0 square metres.
- d. Each floor of a building located above 6 storeys in height should have a maximum horizontal dimension of 60.0 metres as measured along a public street.
- e. Depending on the character area, new development should be designed to form a consistent street edge, based on the following street wall heights:
 - i. 2 to 3 storeys in the Heritage Core;
 - ii. 2 to 4 storeys in the Cultural Core; and,
 - iii. 2 to 6 storeys in the Edge area.
- f. To maintain a high-quality human-scale pedestrian environment, portions of new development above a street wall height should provide a minimum setback (from the street wall) of:
 - i. 3.0 metres in the Heritage Core; and,
 - ii. 2.0 metres in the Cultural Core and Edge area.
- g. If a minimum setback is not achievable, design features that help to accommodate variations in the street wall and distinguish the base of the building from the rest of the building should be provided, including building massing, setbacks, facade articulation, textures and building materials.
- h. To ensure resident privacy and sunlight access for each floor of a building located above 6 storeys in height, the tower separation distance should be a minimum of 24.0 metres from building face to building face. This measure may be reduced to 18.0 metres under the following circumstances:
 - i. between a residential tower and a commercial tower;
 - ii. between two commercial towers;
 - iii. parallel to a north-south street; or,
- iv. for sites that are constrained by various factors such as parcel size or the location of neighbouring buildings.
- i. For each floor of a building located above 6 storeys in height, the tower setback distance should be a minimum of 12.0 metres from a property line shared with another parcel. This measure may be reduced to 9.0 metres under the same circumstances as 4.2.1.h.i to iv.
- j. New tower development should demonstrate that:
 - i. the building envelope does not prevent development from complying on adjoining sites;
 - ii. mitigating strategies are applied to minimize the development impact; and,
 - iii. the arrangement of floor plans minimizes overlooking primary living spaces in adjacent buildings.

Figure 12: Built form considerations

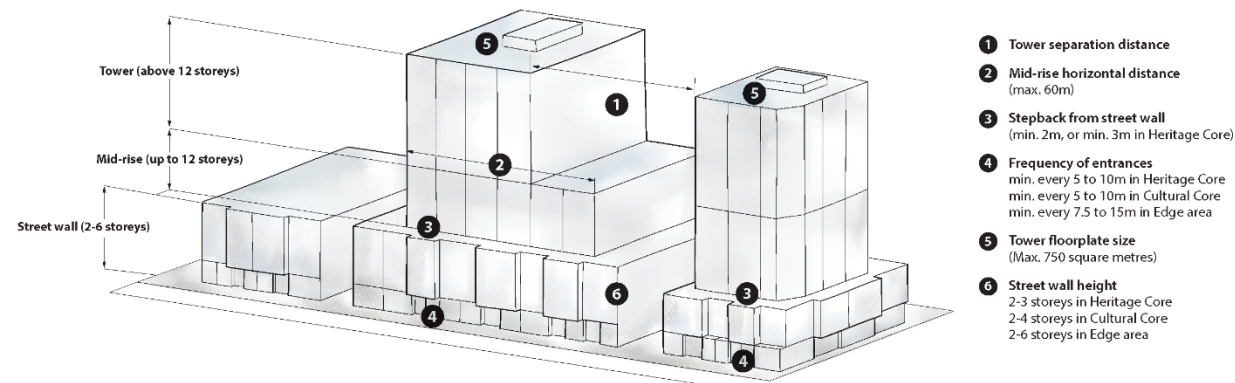

PROPOSED

BYLAW NUMBER 64P2022

Cultural reference

- k.** Layers of character-defining and culturally appropriate elements should be included with all new development and renovation projects through their public realm, site and architecture (see Section 4.1.3, p. 55/56).
- l.** The approving authority will consider modern interpretations of traditional elements if they are inspired by Chinese design principles with cultural significance, but may not necessarily align with the general policies as set out in this Plan.
- m.** Cultural reference and design compatibility should generally be determined and aligned with the location of the project based on the following:
 - i.** Heritage Core area: moderate cultural reference and high design compatibility;
 - ii.** Cultural Core area: high cultural reference and moderate to high design compatibility; and,
 - iii.** Edge area: moderate cultural reference and moderate design compatibility.
- n.** New development should resemble the fine grain scale established in the Heritage Core and Cultural Core with respect to storefront widths, fenestrations, and cornice lines of existing buildings.
- o.** New development should allow for unique street-front commercial unit façades to support cultural expression (e.g. colourful canopies, retractable awnings, convertible storefront windows).

Signage

Chinatown is a visually unique neighbourhood. Multiple influences are evident through the culturally-diverse languages and graphic designs displayed as signage. The following policies aim to continue contributing to the eclectic and pedestrian-oriented ambiance prevalent in Chinatown.

- p.** Both new and renovation projects are encouraged to provide signage that contains both Chinese characters and English for all types of businesses throughout Chinatown.
- q.** To be accessible to people across more language groups, encourage signage design that incorporates icons and pictograms that represents a symbol, a real object or a figure.
- r.** To withstand weathering, encourage signage to be made of durable materials such as metal, neon, glass or acrylic.
- s.** Encourage channel letter signage, which is a 3-dimensional graphic element with an individual structure and separate illumination.
- t.** New neon signage (or other technology that resembles neon) is encouraged to resemble historic neon as an appropriate recalling of the heritage of the area. New neon signage should fit with adjacent buildings and the streetscape and mitigate potential impacts to residents.
- u.** Signage with contemporary interpretation of traditional elements is encouraged to complement the identity and history of Chinatown, except in cases where heritage restoration is pursued.

- v.** Relaxations may be considered for signage that meets the design intent for each character area.
- w.** The size and frequency of projecting blade signage should be proportional to the width of a building façade, to avoid clutter and visual pollution.
- x.** Large projecting blade signage may be allowed in the following locations if they create unique views and promote Chinatown businesses to transit passengers:
 - i.** on the Centre Street S. transit corridor;
 - ii.** along Active Frontages near the future LRT station; and,
 - iii.** near a gateway location along the edges of Chinatown.



4.2.2 Heritage Core

The Heritage Core includes the area approximately one-block between Centre Street S. and 1 Street S.E., and 2 and 3 Avenues S. The west side of Centre Street S. is also included in this area (see Map 4, p. 51). This area is strongly associated with the early settling of Calgary's third Chinatown around the Canton Block. It is tied to the lives of significant people from the community who have played leading roles in establishing the present-day Chinatown.

Identified heritage resources are focused in the western portion of this character area as shown in Figure 13. Other existing buildings and sites on this block were generally constructed or extensively modified during the 'revitalization' period of Chinatown from the 1970s onward. Certain sites may include character motifs and design elements that are more decorative and stylized than early historic development in Chinatown and the remaining heritage resources. These design elements, such as extensive setbacks on portions of 3 Avenue S.E. without ground level storefronts, do not align with early historic development in this location.

Although the look and feel of these later sites contributes to the overall character of Chinatown, future alteration and redevelopment provide an opportunity to unify this location's approach to urban design around an interpretation of Chinatown's early history. When combined with high-quality interpretive features and select cultural expressions, this character area allows community members and visitors to experience and celebrate first-hand a formal part of Chinatown's living history.

Intent

The Heritage Core focuses on conserving and enhancing the existing heritage resources and the surrounding context that further improves this area as the historic centre of Chinatown.

The Heritage Core is characterized by:

- Sensitive alteration, adaptive re-use and additions to heritage resources.
- Contextual buildings and structures that prioritize a low-scale pedestrian environment.
- Cultural expression that does not obscure the heritage context.
- High-quality contemporary interpretations of historic form and design from Chinatown's early periods.

Figure 13: Heritage Core



The illustration is for conceptual purposes only.

1. Chinese Masonic Hall, 1919
2. Chinese National League (Ho Lem Block), 1909
- 3A. Canton Block, 1911
- 3B. Canton Block Extension, 1915
4. National League (Modern), 1954
5. Linda Mae Block, 1950

Figure 13 illustrates sites which have been identified on the Inventory of Evaluated Historic Resources (Inventory) by Heritage Calgary, a Civic Partner of The City of Calgary. The names used for these buildings in The Plan are aligned with their listing on the Inventory according to Heritage Calgary's Historic Resource Evaluation System Handbook, and may not always reflect current tenants or property owners.

4.2.2.1 General

In addition to other policies in the Plan, the following policies apply to the Heritage Core:

Policy

Land Use

- a. New development in the Heritage Core should have historic vertical mixed-use such as retail on the first level, Tong Houses, community organizations or cultural spaces on the second or third level, and residential units on the upper levels.

Site, building and landscape design

- b. New development should have a street wall height of a minimum of 2 storeys and a maximum of 3 storeys, and provide building setbacks and cornice lines compatible with heritage resources to create a consistent streetscape character.
- c. New development should have a similar entrance frequency as historic development in the Heritage Core, with entrances at a minimum of every 5 to 10 metres.
- d. In new development, encourage smaller commercial retail units similar to historic development in the Heritage Core.
- e. Consolidating two or more existing storefronts into a larger unit with uniform rooflines should be avoided to maintain the traditional fine-grain pattern in Chinatown.
- f. New development should have ground-level access to first level commercial spaces to match the existing character of historic development.

- g. Discourage below-ground or split-level entries in the Heritage Core, except where required for building code or flood-mitigation purposes.
- h. The architectural style of new development should seek the highest possible fit with heritage resources and historic development in the Heritage Core without direct imitation — achieved through high-quality modern interpretation of the following elements of early twentieth century commercial architecture:
 - i. simple building form and massing, without extensive articulation;
 - ii. use of masonry cladding (especially red brick) on street wall façades;
 - iii. regular or symmetrical arrangement of windows and doors, with simplified lintels and sills;
 - iv. tall main floor storefronts, with at least 50 per cent glazing and recessed entrances;
 - v. flat roofs, with simplified cornice or frieze elements; and,
 - vi. avoidance of ornamental or highly detailed decorative elements, including cultural motifs.

Cultural reference

- i. Where applicable, encourage the following in the Heritage Core:
 - i. modest modern building character that includes details of early twentieth century commercial architecture;
 - ii. a colour palette focused on natural building materials, with opportunity for traditional Chinese colour placement in building accents rather than primary elements;
 - iii. interpretive features conveying the history of existing or demolished buildings and activities;
 - iv. murals and public art limited to alleyway spaces, and portions of a building that do not visually impact heritage resources;
 - v. lighting features that subtly illuminate existing heritage resources, or enhance new development without districting from heritage resources;
 - vi. the provision of space in the public realm for cultural activities;
 - vii. culturally influenced public realm elements such as string lanterns to intensify the “look and feel”; and,
 - viii. permanent public realm elements directly in front of heritage resources that do not visually distract from an overall historic character.

PROPOSED

BYLAW NUMBER 64P2022

Signage

- j.** Encourage illuminating projecting blade signage for all businesses in the Heritage Core.
- k.** Where historic signage information is available, encourage replacing, restoring or replicating the large, often fluorescent signage that adorned the buildings in the 40s to 60s, and may not be constrained by the maximum allowable size of the signage.
- l.** A maximum of one projecting blade sign for every 5.0 metre section of building façade parallel to the street should be allowed in the Heritage Core area.
- m.** Signage should not obscure architectural elements of a building with historical significance.

Figure 14: Historic examples of characteristic signage on resources in the Heritage Core

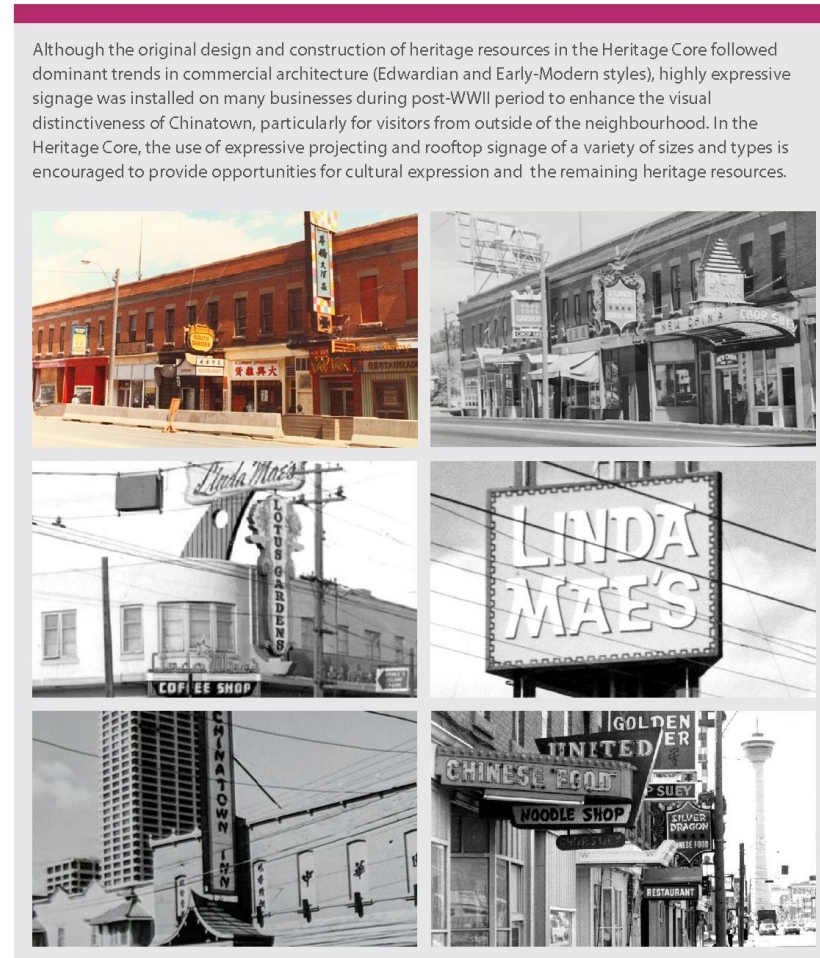

PROPOSED

BYLAW NUMBER 64P2022



Chinatown Cultural Plan

The Canton / Ho Lem Blocks and National League Hall should be secured as affordable cultural spaces, and revived with experiences, neon and art works at the alleyway, façades and rooftops. — **Action E2.2**

Chinatown's Mural Alley could become a real experience. Desired improvements include hanging ornaments, lighting, nighttime performances, movable seating and patios. — **Theme B Map of Aspirations (B)**

4.2.2.2 Heritage resources

Certain culturally influenced design elements and architectural motifs listed on page 55 in Section 4.1.3 may be inappropriate in the Heritage Core, due to the focus on highlighting existing heritage resources, and presenting an urban character that is more representative of the early historic period of Calgary's third Chinatown. The following policies only apply to heritage resources in the Heritage Core:

Policy

Alterations

- a. Proposed alterations to heritage resources should respect the original building style, especially retaining the configuration of original demising walls, and openings such as the historic storefront width and height.
- b. Encourage restoring or recreating documented character-defining or significant historic elements which are no longer present, including (but not limited to):
 - i. the wood and glass storefronts of the Canton Block and Canton Block Extension;
 - ii. the pressed metal cornice of the Canton Block;
 - iii. the original main façade of the Chinese Masonic Hall, including removal of the current façade cladding, and recreation of a historic main floor appearance based on available documentation and/or reference example; and,
 - iv. historic signage on these resources from various periods of Chinatown's history, including rooftop and projection signs.

- c. Painting of historically unpainted materials should not be supported unless for a public art installation or mural when there is no other viable location.
- d. Encourage the use of conservation-safe techniques for paint removal of historically unpainted elements such as the façade of the Chinese National League (Ho Lem Block). Do not use of strong abrasives or mechanical techniques such as power washing or sandblasting for paint removal.

Additions

- e. Additions to heritage resources should prioritize conserving the primary façade appearance, and increase the building area above or behind the primary façade.
- f. Additions to the Canton Block, Canton Block Extension, Chinese National League (Ho Lem Block) or Chinese National League Building are encouraged to use vertical development that keeps opportunities for creating publicly accessible private alleyway spaces, however keeping and conserving heritage resources is prioritized where development objectives may be in conflict.

- g. Vertical additions should minimize visual impact on the historic streetscape through the use of setback, material and colour such as:
 - i. a minimum 3.0 metre setback from the addition to all street-facing façades of heritage resources;
 - ii. the application of high-quality cladding materials that do not closely mimic the heritage resource; and,
 - iii. the avoidance of dark or saturated colours.
- h. Additions should support the overall fit between design and heritage resources by arranging significant elements like windows in a pattern and frequency similar to the heritage resource, while maintaining a distinguishable modern appearance.

PROPOSED

BYLAW NUMBER 64P2022

Heritage resources in the Heritage Core area

Five sites within the Heritage Core have been listed on the Inventory of Evaluated Historic Resources as having city-wide heritage significance. These represent the oldest and most significant remaining buildings in this Chinatown location:

1. Chinese Masonic Hall



2. Chinese National League (Ho Lem Block)



3A. Canton Block



3B. Canton Block Extension

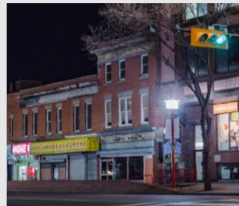

5. Chinese National League (Modern)



6. Linda Mae Block



PROPOSED

BYLAW NUMBER 64P2022

4.2.3 Cultural Core

The Cultural Core expands outwards from the Heritage Core and includes a broad range of historic, cultural and commercial sites such as the Calgary Chinese Cultural Centre, Calgary Chinese Elderly Citizens Association, Sien Lok Park and Dragon City Mall (see Map 4, p. 51 and Figure 15). The Cultural Core also includes a variety of buildings that feature architectural motifs and cultural design features. Design compatibility is important given the evolving character of the area, but a wider variety of existing buildings and sites allow more design interpretation and creativity than is appropriate in the Heritage Core. The Cultural Core offers the greatest opportunity for expression through cultural reference. Authentic Chinese/Asian cultural motifs and design elements are encouraged in a broad variety of styles.

Intent

The Cultural Core focuses on enhancing and developing the most important areas of Chinatown outside of the Heritage Core, including key sites for growth and development, and important spaces for gathering, cultural expression, entertainment, business and living.

The Cultural Core is characterized by:

- Places that offer a continuous, high-quality cultural experience with sensitive transitions.
- Active frontages and medium profile residential development that respects the fine grain and historical block structure.
- Culturally-influenced design.
- Contextual detailing with respect to scale, configuration and rhythm of the street.
- Gathering spaces that are essential for community and cultural activities.
- New development fitting with existing cultural and heritage resources.

Figure 15: Cultural Core

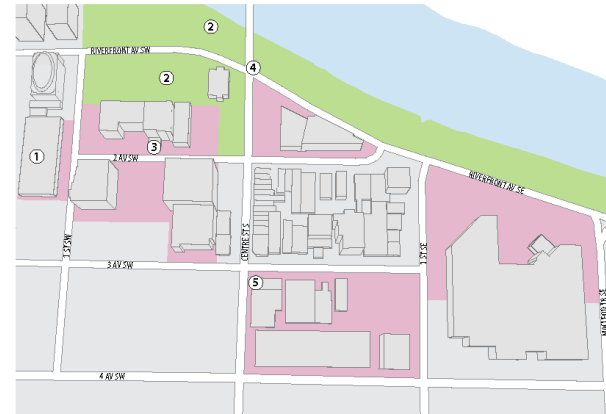

The illustration is for conceptual purposes only.

1. Calgary Chinese Cultural Centre
2. Sien Lok Park
3. Chinese United Church Façade
4. Centre Street Bridge
5. Jade Palace Restaurant Sign

Figure 15 illustrates sites which have been identified on the **Inventory of Evaluated Historic Resources (Inventory)** by Heritage Calgary, a Civic Partner of The City of Calgary. The names used for these buildings in The Plan are aligned with their listing on the Inventory according to Heritage Calgary's **Historic Resource Evaluation System Handbook**, and may not always reflect current tenants or property owners.

PROPOSED

BYLAW NUMBER 64P2022

4.2.3.1 General

In addition to other policies in the Plan, particularly the Active Frontage policies included in Section 3.1.1, (p. 23) the following policies apply to the Cultural Core:

Policy

Land Use

- a. New development in the Cultural Core should have traditional inspired vertical mixed-use such as retail on the first level, Tong Houses, community organizations or cultural spaces on the second or third level, and residential units on the upper levels.
- b. New development in the Cultural Core should contribute to the highest concentration of cultural and gathering spaces.
- c. Multi-level, urban retail configurations are encouraged to accommodate large commercial uses and support a high-quality pedestrian experience.

Site, building and landscape design

- d. New development in the Cultural Core should respond to the established storefront widths, fenestrations and cornice lines of existing buildings along Active Frontages.
- e. Where site frontage is larger than 20.0 metres, the street wall heights and façade articulations should be varied to fit with the contextual scale of the adjacent buildings.
- f. An additional street wall height of 2.5 metres may be allowed to encourage character elements such as cornices and parapets on rooftops subject to urban design performance.
- g. Where building façades, at or below four storeys, face streets or open spaces, the building façade should incorporate recesses and projections (or architectural treatments such as columns or pilasters) every 5.0 to 10.0 metres of horizontal distance, over its entire height.
- h. Combining two or more existing storefronts into a larger unit with uniform rooflines should be avoided to maintain the traditional fine-grain pattern in Chinatown.
- i. Mezzanines should be encouraged, especially at street corner locations, to allow for attractive retail opportunities with greater spatial efficiency, retail visibility and sunlight penetration.

PROPOSED

BYLAW NUMBER 64P2022



Chinatown Cultural Plan

—
More small and mid-sized cultural spaces are needed that are designed for specific purposes. — **Action B2.1**

—
Spontaneous cultural events must be encouraged across Chinatown, with interior spaces, stages, outdoor pavilions and speaker's corners that accommodate events year-round and in any kind of weather. — **Action B2.3**

—
Second Avenue and 3 Avenue are good places to stimulate a street economy and hawker culture. This can also help make better connections between areas east and west of Centre Street.
— **Theme C Map of Aspirations (B)**

Cultural reference

- j.** New development should incorporate high cultural reference (see Section 4.1.3). Multiple layers of cultural expressions applied in the design of architecture, site and public spaces should help to intensify the unique character of Chinatown
- k.** The traditional built form of split-level entries should be allowed where applicable to maintain the character of the retail businesses in the area. For split-level retail businesses, ensure that:
 - i.** adjacent sidewalk widths can accommodate steps and ramps without impacting the flow of pedestrians; and,
 - ii.** featured wayfinding signs, business signs, glass storefronts, visual cues, landscaping and lighting can be provided to attract pedestrian attention to both above ground and below ground businesses.

Signage

- l.** Along Active Frontages (see Map 2, p. 22), layers of projecting blade signage should be used that horizontally projects toward sidewalks and vertically extends to the upper building levels, to create visual interest and culturally appropriate character.
- m.** Signage should not cover up architectural elements of a building with historical significance.

PROPOSED

4.2.3.2 Heritage resources

The policies in this section apply only to identified heritage resources in the Cultural Core:

Policy

- a. The pagoda roof of the Calgary Chinese Cultural Centre has been identified as a significant landmark element for the neighbourhood. Additions to the Cultural Centre, adjacent development and development along view corridors shall keep sightlines to this element of the heritage resource.
- b. Change and/or redevelopment on properties adjacent to Sien Lok Park shall demonstrate sensitivity to this cultural landscape.
- c. In recognition of Sien Lok Park's role as a significant cultural landmark and amenity, support the redesign or reconstruction of the park to:
 - i. recognize the legacy of the Chinese community; and,
 - ii. incorporate opportunities to further recognize the historic downtown and riverbank preservation efforts of the Sien Lok Society and Calgary's Chinese community.

Heritage resources in the Cultural Core area

The Cultural Core contains five sites listed on the Inventory of Evaluated Historic Resources, including the Calgary Chinese Cultural Centre, Sien Lok Park, the Jade Palace Restaurant Sign, Centre Street Bridge, and façade elements of the former Chinese United Church. As the final three sites are non-building resources, direction in this character area focuses on the following two resources:

Sien Lok Park



South (Phase 1) portion of Sien Lok Park



North (Phase 2) portion of Sien Lok Park

Calgary Chinese Cultural Centre



East view of the Calgary Chinese Cultural Centre from 2 Ave SW.



Interior pagoda roof detail

4.2.4 Edge area

The Edge area interfaces with adjacent neighbourhoods and the riverfront (see Map 4, p. 51 and Figure 16). The Plan recognizes that over the years, a few culturally inharmonious developments have eroded the edges of Chinatown. The Edge area is intended to reclaim and strengthen the edges of Chinatown while maintaining continuity with the Heritage and Cultural Cores. This relationship between Chinatown and surrounding areas of downtown can be done through re-establishing the urban fabric and incorporating contemporary interpretations of traditional elements in site, building and public realm design.

Intent

Ensure that new development in the Edge area:

- Contributes to neighbourhood character and placemaking
- Fits the design compatibility and cultural references expressed through the modern interpretation of traditional elements at strategic locations to extend the “look and feel” of Chinatown
- Provides built form transitions to the Cultural Core area, surrounding neighbourhoods, riverfront promenade and other public spaces
- Integrates well with the future LRT corridor and station, and improves the “last mile” connection for pedestrians and their experience along key east-west pedestrian routes
- Reclaims and strengthens the edges of Chinatown through a variety of built forms and identifying features

Figure 16: Edge area



The illustration is for conceptual purposes only.

PROPOSED

BYLAW NUMBER 64P2022



Chinatown Cultural Plan

Not all Chinatown gateways have to look the same. Maybe Calgary Chinatown could be a bit different and mark the entry points of its community with large (light) art structures. — **Theme E Map of Aspirations (E)**

4.2.4.1 General

In addition to other policies in the Plan, the following policies apply to the entire Edge area:

Policy

Land Use

- a. Large at-grade commercial uses that exceed 1,200 square metres should be combined with other uses.
- b. Multi-level, urban retail configurations are encouraged to accommodate large commercial uses and support a high quality pedestrian experience.

Site, building and landscape design

- c. New development proposed in gateways should provide enhancement features to reinforce pride and identity and strengthen the edges of Chinatown, while providing character and scale transition between Chinatown and adjacent neighbourhoods.
- d. New development should demonstrate a form-based transition in scale relative to development located in the Heritage Core and Cultural Core. A combination of the following design strategies should be applied to mitigate massing, shadow, view, and privacy impact:
 - i. step down heights and decrease scales incrementally through a block toward the riverfront promenade;
 - ii. provide upper level setbacks and/or greater façade articulations along the street walls that interface with open spaces, active frontages, or Cultural Core areas in general;
 - iii. reduce the street wall height to transition the visible mass of a taller building to match the cornice line for a shorter building;
 - iv. buffer higher-intensity development from lower-intensity development using landscaping and setbacks;
 - v. design buildings to have complementary massing and street wall heights if applicable on both sides of the street; and,
 - vi. use smaller or narrower floor plates and increased distances between towers to reduce shadowing impact, provide more light for surrounding residential units, and allow flexibility for potential conversion of office buildings to residential.
- e. Where building façades, at or below the sixth storey, face the streets or open spaces, the building façade should incorporate recesses, projections or other architectural treatments every 7.5 to 15.0 metres of horizontal distance, over its entire height.

Cultural reference

- f. New development should incorporate cultural reference (see Section 4.1.3, p. 55/56) at strategic locations (such as gateways, Active Frontages, street and building corners, building entrances or public transit system stations) using contemporary interpretation of traditional elements. Multiple layers of cultural expressions applied in the design of architecture, site and public realm should help to strengthen the edges of Chinatown.

Signage

- g. Along the Active Frontages, layers of projecting blade signage should be used, that horizontally projects toward sidewalks and vertically extend to the upper building levels, to create visual interest and culturally appropriate character.

PROPOSED

BYLAW NUMBER 64P2022



5

**Mobility and
utility infrastructure**

交通易行性與基礎設施

交通易行性与基础设施

PROPOSED

BYLAW NUMBER 64P2022

5.1 Mobility

Moving around the city should be safe and convenient for people of all ages, genders, incomes and abilities. Mobility refers to a well-connected network that includes options for walking, bicycling / wheeling, taking transit, and using personal vehicles (see Map 5, p. 73). It also provides people with travel choices that meet a variety of needs and preferences year-round. Recognizing the business needs in Chinatown, the mobility network needs to support local deliveries and a high level of curbside activity. Winter travel should account for a high number of pedestrians and ensure a safe and accessible mobility network, critical to achieving thriving and resilient neighbourhoods.

The overall goal of the policies in this section is to provide direction for the development of mobility infrastructure that connects people to destinations, drawing on previously Council-approved documents such as **Calgary's Greater Downtown Plan**, the **Calgary Transportation Plan**, and within it, the **Always Available for All Ages & Abilities (5A) wheeling network** and the **Primary Transit Network** (both as shown in Part 8 of the **Calgary Transportation Plan**). These policies guide the review of planning applications for development that contributes to publicly accessible amenities, infrastructure and facilities.



Chinatown Area Redevelopment Plan

Mobility and utility infrastructure

PROPOSED

BYLAW NUMBER 64P2022

Map 5: Mobility

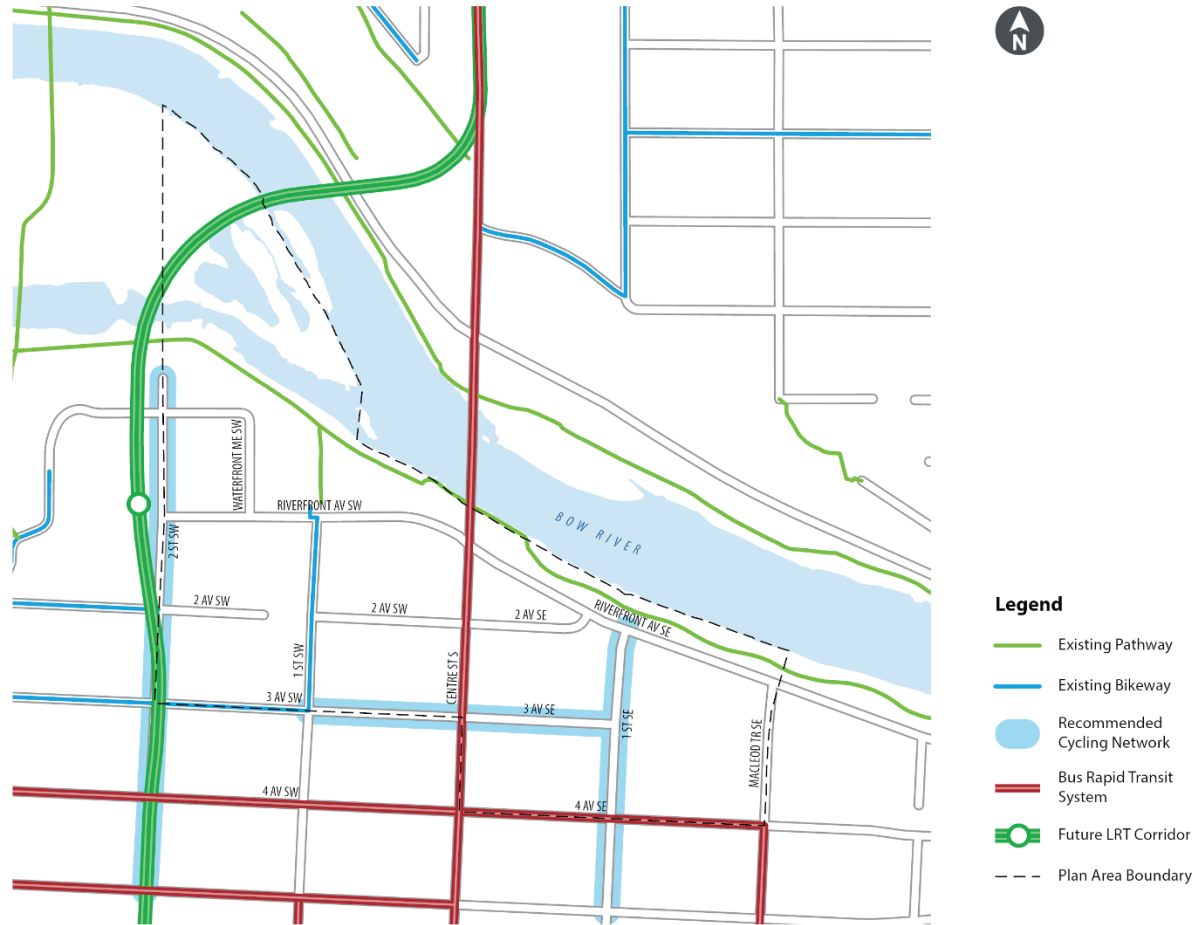

PROPOSED

BYLAW NUMBER 64P2022



Chinatown Cultural Plan

Chinatown's streets could be more intentionally designed with the youngest and oldest residents in mind. Traffic safety and accessibility are major concerns, and more places to linger and socialize are desired. — **Action E1.1**

Chinatown is an excellent location for people-oriented streets that accommodate all sorts of uses, can be closed off for cultural events, and where all traffic modes share space in a safe, vibrant environment – day and night. — **Action E1.3**

5.1.1 Pedestrian

Pedestrian routes are a critical piece of a well-connected mobility network at street level and within the Plus 15 network. Part of Chinatown's vibrancy can be attributed to the number of people walking in the area. Unlike most neighbourhoods in Calgary, walking and transit are the primary ways people travel to and from work in this area.

With a large proportion of older adults, attention needs to be paid to pedestrian routes that accommodate a high number of people of all ages and abilities. There is also a high rate of jaywalking, so strategies are needed to discourage this activity or identify opportunities to install pedestrian crossings mid-block as a way to provide a predictable locations for pedestrians to cross, improving safety.

Policies in this section guide the development of pedestrian infrastructure in Chinatown.

Policy

- a. Temporary uses in the street should use on-street parking spaces, ensuring the existing pedestrian spaces, sidewalks or bus zones are clear.
- b. Enhanced pedestrian connections may be supported by additional mid-block crossings along Riverfront Avenue S., 2 Avenue S. and 3 Avenue S.
- c. Explore opportunities to improve pedestrian comfort and connections through strategies such as advanced walk signals or scramble crosswalks to increase walk time given at intersections.
- d. Explore the use of curb extensions to reduce crossing distance and improve pedestrian visibility.
- e. Explore the provision of additional seating along 1 Street S.W., 2 Avenue S. and 3 Avenue S. to provide resting points for people.
- f. Explore the use of contrasting sidewalk colours or materials to separate walk zones from furniture or planting zones.
- g. Pedestrian wayfinding signage should be placed near or at transit stops, pathway connections, intersections and entrances/exits to the Plus 15 network.
- h. Pedestrian wayfinding signage should direct pedestrians to and from Chinatown.



PROPOSED

BYLAW NUMBER 64P2022



Chinatown Cultural Plan

Locals and visitors would benefit greatly from economic activity on Chinatown's streets, including night markets, all-season patios, and (after-hours) food and retail stalls, as well as late-night events. — **Action C3.1**

5.1.2 Biking and wheeling

Lanes for biking and wheeling (to accommodate scooters and other lightweight forms of human powered vehicles) are critical to the mobility network. Biking and wheeling infrastructure should be convenient, safe, comfortable, accessible and provide connections within the area and to the city-wide network.

Biking and wheeling facilities come in many forms, both on-street and off-street. Pathways are typically located off-street and are separated from the roadway. Pathways accommodate people walking and wheeling. Bikeways are typically on-street and reserved for people who wheel.

The Chinatown neighbourhood includes portions of the Bow River Pathway System and is close to the existing 5A (Always Available All Ages and Abilities) biking and wheeling on-street, separated bikeways network. Chinatown is well positioned to connect to these networks, providing a seamless experience for people living, visiting or working in Chinatown.

Policies in this section guide the development of biking and wheeling infrastructure in Chinatown.

Policy

- a. Chinatown should be connected to the city-wide 5A biking and wheeling network, as shown in the **Calgary Transportation Plan**. This includes comprehensive, complete and permanent bikeway and pathway connections east-west and north-south.
- b. Improve connections and transitions between bikeways, pathways and transit corridors.
- c. Public bicycle parking should be located near entrances of buildings in highly visible and well-lit areas whenever possible.
- d. To encourage and support people biking or wheeling to the area, additional seasonal or temporary secure biking and wheeling parking may be provided on-street through the conversion of on-street parking stalls at high demand locations or in public parking facilities.



5.1.3 Transit

Transit service is another critical element of the mobility network, connecting people to destinations across the city. A fast, frequent and reliable transit system can improve access into and out of Chinatown. The future Light Rail Transit (LRT) corridor runs along the Chinatown / Eau Claire border, with a station near 2 Avenue S.W.

Policies in this section guide transit connections and the transit customer experience in Chinatown.

Policy

- a. Transit stops or Bus Rapid Transit stations can be either as stand-alone structures or integrated with adjacent development. Where development opportunities arise, seamless integration with these stops/stations is encouraged by providing on-site transit shelters or amenities that promote placemaking for people while waiting for the transit service.
- b. New development located adjacent to Light Rail Transit and/or Bus Rapid Transit stations should seamlessly integrate with these facilities (e.g. orient entrances to the station, provide shelter and additional setbacks).
- c. Transit stops should be safe, comfortable, accessible and convenient for all. They should be sized, both in length of curbside and amount of sidewalk/stop space, to accommodate the large number of people on the Centre Street S. corridor.
- d. Centre Street S. is identified in **Calgary's Greater Downtown Plan** as being within the Primary Transit Network and is critical for transit operations and connectivity through Chinatown and to the Greater Downtown area. Development and investments along Centre Street S. should continue to accommodate efficient transit service through the area.



Rapid Transit Corridor

Corridors that allow for fast, frequent and reliable transit service, usually through transit priority measures such as dedicated lanes or rights-of-way and transit priority signals.

PROPOSED

BYLAW NUMBER 64P2022

5.1.4 Parking

The following parking policies support flexibility in how and where parking is provided, which can incentivize development in locations that support a range of mobility, housing and commercial options. Managing parking at the area-wide scale, rather than site-by-site, may result in more efficient land use and parking. Parking policies and regulations need to be adaptive to current needs while allowing neighbourhoods to be more responsive to future trends.

Chinatown is served by a mix of private and city-owned parking lots and parkades. In addition, there are on-street parking spaces available throughout the neighbourhood. The area has a high density of retail businesses but lower overall job density when compared to other Greater Downtown neighbourhoods. The population-base is also higher than most other areas. This mix will tend to see more short-term vehicle trips and fewer all-day trips than other nearby Greater Downtown neighbourhoods have, requiring a different combination of parking choices.

In Chinatown, there is a high concentration of historic commercial properties that have minimal or no on-site parking or loading facilities. This situation adds pressure to on-street loading zones for commercial deliveries, which reduces the overall amount of curbside parking spaces available for visitors.

Policies in this section guide the development of parking infrastructure in Chinatown.



PROPOSED

BYLAW NUMBER 64P2022

Policy

- a. No new temporary or permanent at grade parking lots shall be allowed as a stand-alone use.
- b. The term of renewal for an existing temporary at-grade parking lot shall not extend beyond three years.
- c. Consider shared off-street parking solutions within comprehensive mixed-use development or nearby sites where the peak parking demands for such development are substantially different from each other (e.g. uses with evening and weekend peaks compared to uses with daytime peaks).
- d. Explore opportunities to convert on-street parking stalls to shared micromobility parking as the demand for shared micromobility increases.
- e. Consider reductions or relaxations to parking requirements:
 - i. where development use includes transportation demand management measures;
 - ii. for development of affordable housing as defined and accepted by The City; and,
 - iii. for development of special care facilities.
- f. Where surface parking is renewed, it should:
 - i. include at least 25 per cent short stay parking (4 hours or less);
 - ii. include pedestrian routes and landscaped areas to minimize visual and environmental impacts;
 - iii. support adaptive reuse or temporary use of space, such as parking for food trucks or space for community pop-ups; and,
 - iv. incorporate edge treatments that improve the interface with the pedestrian areas through landscaping, public art or seating, and incorporate principles of crime prevention through environmental design (CPTED).
- g. Parking structures with non-residential uses should:
 - i. identify opportunities to incorporate non-parking uses on the ground floor;
 - ii. be integrated into development to minimize their visual impacts on the street;
 - iii. include at least 25 per cent short stay parking (4 hours or less);
 - iv. use designs that support future adaptive reuse through strategies such as flat decks, appropriate garage layout and floor-to-ceiling heights that allow for a range of uses;
 - v. incorporate charging infrastructure for electric vehicles;
 - vi. ensure stairs for parking access are highly visible at all levels from the street;
 - vii. consider new parking technologies (i.e. robo-garages); and,
 - viii. explore opportunities for roof tops to include amenities such as park or event space.

Site access and loading

- h. Where an on-street bicycle route with a protected cycle track is built or proposed, access to off-street parking and loading should be avoided.
- i. Where a transit-only lane is built or proposed, access to off-street parking and loading should be avoided.

5.1.5 Street network

The street network is an important part of the public realm and should provide functional, safe and efficient connections within the Chinatown neighbourhood and to other parts of Greater Downtown and the city as a whole. The network must support a range of mobility options with priority placed on providing the best experience for walking, bicycling/wheeling and transit, while carefully considering impacts to vehicles and goods movement and deliveries. A street network is typically comprised of any roads, alleyways (lanes), and other types of mid-block connections. In Chinatown, most blocks do not have alleyways. A lack of alleyways concentrates activities along street frontages, whether it is business access by customers or employees, or delivery activities. This situation is most pronounced along 2 Avenue S., 3 Avenue S. and 1 Street S.E., where there are a high number of small businesses.

Policies in this section guide the development of infrastructure related to the street network in Chinatown.

Policy

- a. New public or internal publicly accessible private streets are encouraged where connections are missing in longer blocks or where alleyways do not exist (e.g. Harry Hays site).
- b. Closing permanent roadways or alleyways may be considered where there is an opportunity to reconfigure, enlarge or improve the functionality of an existing open space or publicly accessible private open space.
- c. The temporary closure of roadways should be supported to provide additional public space within Chinatown for community events.
- d. Notwithstanding policy 5.1.5.c, temporary closure of roadways should not impact critical transit operations such as those running along Centre Street S. and 4 Avenue S.
- e. River crossings shall minimize impacts on the natural characteristics of the area including the wetland, riparian areas and trail system. Factors to be considered when planning, designing and constructing these crossings includes:
 - i. waterway constraints (stream corridor considerations and riparian areas);
 - ii. location and design of river crossings;
 - iii. maintenance of the natural characteristics of the east end of Prince's Island Park;
 - iv. minimizing impacts on parks and natural areas; and,
 - v. incorporating river crossing design principles.



5.2 Utility infrastructure

This section outlines various mechanisms to provide services related to growth. The policies address different themes including protecting public health, safety, financing, environment and property.

The overall goal of these infrastructure policies is to provide efficient, safe, social and environmental infrastructure that supports water distribution, wastewater collection, stormwater collection and flood protection.

These policies align with a number of City policy documents such as The **Municipal Development Plan** (MDP) and the Centre City Levy (CCL) Bylaw. The Plan also includes new policy guidance that considers and reflects recent advancements in infrastructure planning.

5.2.1 Utility infrastructure funding

Chinatown will continue to be part of the Centre City levy by-law. Any significant infrastructure investments resulting from The Plan will continue to be funded by this levy bylaw, pending any changes, and The City, through utility rates.

The following policy is to direct utility infrastructure funding for Chinatown in the future.

Policy

- a. The City shall continue to promote safe, efficient and affordable utility infrastructure solutions that reduce overall life cycle costs to support future growth in Chinatown.

PROPOSED

BYLAW NUMBER 64P2022

5.2.2 Water, sanitary and shallow utility servicing

Utility infrastructure within Chinatown was designed to meet development needs of the time. Changes to needs based on redevelopment would require retention of the level of service. Chinatown is located within the Inner-City/Glenmore Sanitary District Study (SDS) area and the Glenmore water pressure zone. Servicing into the area for capital infrastructure is evaluated regularly through periodic updates to the Water Long Range Plan and Sanitary Long Range Plan programs. At this time, there are no existing or future upgrades currently identified within the plan area in either long-range plan. However, depending on future land use changes, there may be associated local upgrades required. Local servicing capacity would be evaluated through the established development application process.

The following policies are to facilitate orderly and efficient water, sanitary and shallow utility servicing for Chinatown in the future.

Policy

- a. Development shall be serviced with municipal water, sanitary sewer and stormwater infrastructure. Shallow utility services (e.g., gas, cable, electricity, and telephone) shall be provided by utility providers, as determined through the approvals process.
- b. Provision, alignment and capacity of water distribution mains, sanitary sewer mains and trunks, and stormwater mains and trunks within a development should be in accordance with City standards and confirmed through reviews of a development site servicing plan, a fire flow letter and a sanitary servicing letter as deemed necessary by The City during development review.
- c. The City should identify any off-site water, sanitary or stormwater system improvements required to be up-sized prior to development.
- d. Depending on the increase in intensity, development application requirements may require a detailed utility infrastructure study, which includes a water network plan and a sanitary servicing study, to demonstrate that the subject site can be serviced. Constraints that are determined with the intensification may require upgrades that would be at the cost of the developer.
- e. The location of utility rights-of-way, easements and public utility lots should be addressed:
 - i. to the mutual satisfaction of The City and the utility companies; and,
 - ii. to accommodate the extension and maintenance of municipal utilities necessary for development.
- f. Explore opportunities to relocate any existing overhead utilities to underground in conjunction with future public realm/public infrastructure opportunities in Chinatown.
- g. Consider efficiency measures within new development to reduce potable water consumption.
- h. New development application proponents should collaborate with The City to explore and evaluate opportunities to potentially reduce fire flow demands.



5.2.3 Stormwater management

The stormwater management system should be designed to adequately and efficiently service redevelopment and adopt Low-Impact Development (LID) strategies where appropriate.

Stormwater management within established older neighbourhoods in Calgary, such as Chinatown, poses a significant challenge. The expected loss of pervious surfaces due to increasing intensification/density in older neighbourhoods, combined with limited opportunities for incorporating large storage ponds and the increasing impacts of climate change, means older neighbourhoods need to consider multiple approaches to addressing stormwater management going forward. The following policies are proposed to capture a multi-layered approach to addressing stormwater in the plan area.

Policy

- a. Existing municipal stormwater infrastructure shall be extended to the site of any new development at the cost of the developer. On-site stormwater detention may be required based on the land use to reduce impacts on pipe capacity.
- b. The provision, alignment and capacity of any new stormwater mains and trunks within the plan area shall be in accordance with City standards and confirmed through the Development Site Servicing Plan (DSSP).
- c. The stormwater management system for any development should be designed to:
 - i. adequately and efficiently service the development while preserving riparian and wetland areas, where possible; and,
 - ii. anticipate climate change impacts to precipitation patterns, including the increased frequency of heavy rainfall events.
- d. Application information submitted should demonstrate how runoff from impervious surfaces will be treated.
- e. Any requirements for new stormwater outfall discharge locations, maximum allowable release rates, unit area release rates, runoff volume control targets and stormwater treatment should be consistent with the approved drainage plans for the plan area.
- f. Consider adding low-impact development strategies within new development to reduce stormwater runoff volume and peak flow and treat stormwater as a resource rather than a waste product. Such strategies may include, but are not limited to:
 - i. source control practices such as absorbent landscaping, bioswales and rain gardens;
 - ii. rainwater harvesting/reuse for irrigation; and,
 - iii. redirecting surface runoff to landscaped areas, where appropriate.
- g. Explore potential opportunities for alternative and innovative stormwater management practices integrated with projects such as upgraded transportation corridors and recreational facilities/parks within the plan area.



5.2.4 Flood hazard areas

Chinatown is located adjacent to the Bow River and within the flood fringe hazard area. Climate change models show flood events will likely occur more frequently and severely than in the past. Proactive approaches to increase flood protection in design are required to help avoid risks of overland river flooding and associated hazards such as high groundwater.

Calgary has undertaken significant work to reduce the risks of river flooding. In the case of Chinatown, a new downtown flood barrier (2024 estimated completion) is under construction along the Bow River that will provide the neighbourhood with significant flood protection (see Figure 17, p. 84). Two other flood control projects in the area, the West Eau Claire flood barrier and the Centre Street Bridge demountable flood barriers, were both completed in 2018. Other structures that protect the neighbourhood include the Ghost Reservoir farther upstream on the Bow River, which can hold back water and reduce the impacts of small and moderate floods. Building regulations, such as the Land Use Bylaw, require elevations to protect the building and the associated mechanical/electrical systems from flood hazard areas. It should also be noted the Government of Alberta is currently updating flood maps for Calgary. Once completed, this information may have an impact on neighbourhood-level regulatory tools such as the Land Use Bylaw. Additional implications on developing in Calgary's flood hazard areas, including Chinatown, will be known at a future date. Finally, because the risk of major floods cannot be completely eliminated, property owners, building managers and residents in Chinatown are encouraged to take steps to protect their properties from flooding and have a flood emergency plan.



The following policies are proposed to help facilitate flood protection for Chinatown in the future.

Policy

- a. The design of any utility infrastructure should address flood conditions, if applicable, to ensure long-term infrastructure resilience.
- b. The design of new buildings should include high standard groundwater considerations to ensure they are designed to address the high groundwater levels associated with a river flood.
- c. No new residential uses shall be allowed to be developed below the designated flood level.
- d. Development located within the Flood Fringe should be designed in accordance with Flood Fringe policies of the Municipal Development Plan and Land Use Bylaw.

PROPOSED

BYLAW NUMBER 64P2022

Figure 17: Flood protection



Legend

Flood Control Structures

- Centre Street Bridge
- Demountable Flood Barrier
- Downtown Flood Barrier
- Plan Area Boundary

PROPOSED

BYLAW NUMBER 64P2022



6

Implementation and interpretation

實施與詮釋

实施与诠释

6.1 Policy framework

The Municipal Government Act outlines the purpose and scope of powers for municipalities in Alberta. The Plan is a statutory area redevelopment plan that establishes a long-range framework for land use, urban design, mobility and utilities for the Chinatown neighbourhood. The Plan is meant to be updated periodically as development and change occur, but is envisioned to provide direction for the next 30 years.

The Plan has considered and is in alignment with the **South Saskatchewan Regional Plan** and the **Calgary Metropolitan Region Growth Plan (Growth Plan)**. The Plan must be read in conjunction with the **Municipal Development Plan (MDP) Volume 1**, the **Calgary Transportation Plan (CTP)**, the **Municipal Development Plan (MDP) Volume 2, Part 2, Chapter 4**, and any other City of Calgary policy and guiding documents as indicated in the Plan.

6.1.1 Hierarchy of plans

The Municipal Development Plan

Calgary's Municipal Development Plan (MDP) is a statutory plan that lays out a vision for how the city will grow and develop over the next 30 to 60 years. Together with the Calgary Transportation Plan (CTP), MDP Vol 3 as approved with Bylaw 49P2020, the MDP sets a long-term strategy for a more sustainable built city and transportation network. Collectively the plans encourage growth within the city to make the best use of serviced land, reduce the cost of City services, locate residents closer to where they work, shop and play, and better support a variety of mobility options.

The long-range target of the MDP is to house 50 per cent of Calgary's future population growth within the Balanced Growth Boundary. This highlights the significant opportunity to further develop the Greater Downtown and in and around Activity Centres and Main Streets.

In 2017, Council adopted the Centre City Guidebook (CCG), which forms Vol 2, Part 2 of the MDP. It states that the CCG only applies when a local area plan within Greater Downtown says it applies. While the framework, best practices and common policies in the CCG provide great considerations to start planning, it's only the policies in Chapter 4.0: Urban Design that apply to this Plan. See Section 6.2.1 (a) and (b) and 6.3.1 (a) for additional information.

Calgary's Greater Downtown Plan

Calgary's Greater Downtown Plan is a non-statutory plan that sets out the roadmap and commitment to support reinventing Greater Downtown neighbourhoods. They are the Downtown Core, Downtown West, Eau Claire, Chinatown, East Village and Beltline. A primary consideration in any new policy work for Greater Downtown, including Chinatown, is the vision and principles outlined in the Calgary's Greater Downtown Plan.

Chinatown Area Redevelopment Plan

The Chinatown Area Redevelopment Plan serves multiple functions:

- provides a neighbourhood-specific vision for Chinatown based on community feedback;
- explains the priorities and policies that guide this Plan;
- defines the actions to achieve the vision.

Figure 18: Policy relationship

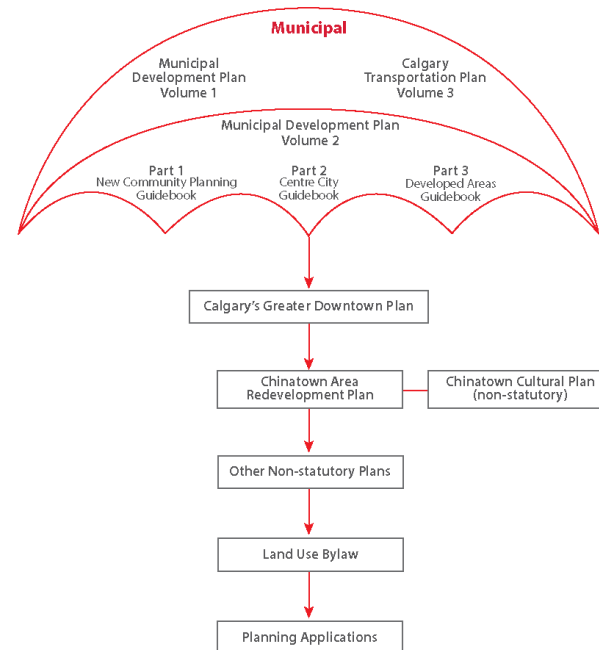

6.2 Interpretation

6.2.1 Policy interpretation

- a. The South Saskatchewan Regional Plan (SSRP), which refers to a large geographic area that includes Calgary — establishes a long-term vision for the region. It uses a cumulative effects management approach (ripple effect of development) to guide local decision-makers in land use and watershed management. The SSRP is designed to support Alberta's economic, environmental, and social goals. However, this Plan allows The City to encourage more progressive policies for economic, environmental and social outcomes.
- b. The Growth Plan provides a policy framework for managing growth and implementing a long-term vision to accommodate the next million residents and about half a million jobs in the region. It provides strategies and policies for planning and managing future population and employment growth to help achieve vibrant inclusive communities while protecting and enjoying the environment. This Plan builds on and is in alignment with the policies of the Growth Plan. Placetypes are elements of the Growth Plan that describe generalized land use categories at a regional level. The Plan area is predominantly categorized as the Infill and Redevelopment Placetype as shown on Map 7 (p. 110) in Appendix D.
- c. In 2017, Council adopted the Centre City Guidebook (CCG), MDP Vol 2, Part 2, that only applies when a local area plan says it applies. The MDP says that the CCG framework, best practices and common policies should be used as a starting point to neighbourhood planning. However, as the second approved guidebook within the MDP, the CCG addresses only two land use categories: Mixed-Use High Density for the neighbourhoods surrounding the Downtown Core; and Employment - Intensive for the commercial and retail areas in the Downtown Core.

Further, it recognizes that these categories may not fit every local context within Greater Downtown and proposes an area redevelopment plan approach would be better. With its diverse neighbourhood, Chinatown is a perfect example of when exceptions should supersede the CCG. Further, the significant updates to the MDP in 2021 make much of the CCG redundant. For all these reasons, the CCG policies in Chapter 4 is the only CCG content that applies to this Plan.
- d. The policies in Chapter 4 of the CCG will apply to the Chinatown plan area and must be read in conjunction with the Chinatown Area Redevelopment Plan. Where the policies in Chapter 4 of the CCG and this Plan are different, the difference is intentional; policy has been tailored to Chinatown. Where there is an absence of a specific policy in this Plan, Chapter 4 of the CCG prevails.
- e. Policies that use the words "shall," "will," "must" or "require" apply to all situations, without exception, usually in relation to a statement of action, legislative direction or situations where a desired result is required.
- f. The word "should" is explicitly used to further clarify the directional nature of the statement. Policies that use active tense of "should" are to be applied in all situations, unless it can be clearly demonstrated to the The City of Calgary that the policy is not reasonable, practical, or feasible in a given situation. Proposed alternatives will comply with MDP and CTP policies, intent and guidelines to the satisfaction of The City related to design and performance standards.
- g. Where an intent statement accompanies a policy, it is provided as information only to clarify the intent and enhance the understanding of the subsequent policies. If an inconsistency arises between the intent statement and a policy, the policy takes precedence.

6.2.2 Map interpretation

- a. Unless otherwise specified in this Plan, the boundaries or locations of any symbols or areas shown on a map are understood to be approximate. The maps are not intended to define exact locations except where they coincide with clearly recognized landmarks or fixed boundaries such as property lines, roads or utility rights-of-way. The precise location of these boundaries, for the purpose of evaluating development proposals, will be determined by the approving authority at the time of application.
- b. No measurements of distances or areas should be taken from the maps in this Plan.
- c. All proposed land use classifications, additional policy guidance, road and utility alignments and classifications may be subject to further study. They may also be further delineated at the land use amendment stage to comply with applicable policies. Any major changes may require an amendment to this Plan that includes a Public Hearing of Council.

6.2.3 Figure interpretation

- a. Unless otherwise specified within this Plan, the boundaries or locations of any symbols or areas shown on a figure are understood to be approximate. Figures are not intended to define exact locations, except where they coincide with clearly recognize landmarks or fixed boundaries such as property lines, roads or utility rights-of-way.
- b. Unless otherwise specified within this Plan, actual quantities or numerical standards are contained in figures shall be interpreted as conceptual only and will be determined at the detailed design stage.
- c. All illustrations and photos are intended to convey concepts of what may take shape after the Plan's policies and guidelines are implemented. They are not exact representations of an actual development intended for Chinatown.

6.2.4 Appendix interpretation

- a. The appendices to this Plan are not statutory. Their intent is to provide further understanding of the policies reflected in this Plan.

6.2.5 Plan limitations

- a. Policies and guidelines in this Plan are not to be interpreted as an approval for a use on a specific site. No representation is made herein that any particular site is suitable for a particular purpose. Detailed site conditions or constraints must be assessed on a case-by-case basis as part of a proposal for an outline plan, land use amendment, subdivision or development permit.

6.2.6 Existing caveats/restrictive covenants

- a. Some land parcels in the plan area may have caveats registered against the certificate of title which may restrict development. In some cases, the caveats may align with the goals and objectives of this Plan. Where there are conflicts, The City supports the direction of this Plan. It is a landowner's responsibility to have caveats discharged from their land title certificate.

6.3 Implementation

6.3.1 Using the Plan

- a. The Plan is intended to be read in conjunction with the following plans, which provide city-wide policy direction as well as policy direction for Calgary's Greater Downtown:
 - i. Municipal Development Plan (MDP Volume 1, Part 1) and Calgary Transportation Plan (CTP); and,
 - ii. Centre City Guidebook (MDP, Volume 2, Part 2), Chapter 4: Urban Design.
- b. Additional policy and guidance are provided for Greater Downtown through non-statutory plans such as Calgary's Greater Downtown Plan, Centre City Mobility Plan and the Centre City Urban Design Guidelines.
- c. New concepts and ideas may arise that are constrained by or contradictory to certain policies within this Plan. Where new concepts and ideas align with the intent of the vision in the Plan (Chapter 2), or offer creative solutions to particular problems, amendments may be supported. To make any change to the text or maps within the Plan, an amendment must undergo a Public Hearing of Council.

6.3.2 Monitoring

- a. The policies within the Plan will be monitored to ensure developments in Chinatown remain relevant to the intent of the Plan, and that the Plan remains current with Chinatown's evolving interests. City Administration will follow the plan amendment process — in accordance with the Municipal Government Act — to update the Plan as required.
- b. At a minimum, the Plan will be reviewed every 10 years or when significant changes are made to the Chinatown Cultural Plan. Administration should monitor the Plan for policy interpretation issues, policy gaps, implementation processes, and, changes to corporate objectives.

6.3.3 Review

- a. In reviewing all land use amendment and development permit applications, the approving authority should consider the context and compatibility of proposed development relative to boundaries of the Character Areas.
- b. Development permit applications that impact gateway conditions and landmark view corridors should be referred to the Calgary Planning Commission for decision.
- c. Proponents of land use redesignation and discretionary use development permits for sites greater than 5,000 square metres (1.2 acres) should include community outreach to seek input from community groups, tongs and associations, including the Chinatown Community Association and Chinatown BIA, prior to formal submission of application(s) to The City. Efforts should be made to translate community outreach communications.
- d. All land use redesignation and discretionary use development permit applications for sites greater than 5,000 square metres (1.2 acres) should be circulated for review by and input from community groups, tongs and associations, including the Chinatown Community Association and Chinatown BIA.
- e. To support net-zero and net-zero ready projects or developments that use climate resilient building materials and/or include community climate resilience assets, The City should consider all available opportunities, including but not limited to variances to applicable development standards, and relaxations to the Land Use Bylaw and other policies that guide building design including, but not limited to, building setbacks, stepbacks, height, façade articulation, parking minimums, and use composition.

6.3.4 Amendments

- a. Where an amendment to the Plan is requested through a planning application, the applicant must submit the supporting information necessary to evaluate and justify the potential amendment and ensure its consistency with the MDP and other relevant policy documents.
- b. Any change to the text or maps within this Plan shall require an amendment to the Plan that includes a Public Hearing of Council.

6.4 Glossary

Please see the Glossary in the **Municipal Development Plan** for definitions you don't find here.

A

active frontage — The portions of a building where the ground floor uses must be commercial to create a more vibrant and safer pedestrian environment and contribute to activity on the streets throughout the day and evening.

arcade — A roofed exterior passageway lined with a colonnade along at least one edge.

articulation — The manner in which the exterior of a building form is designed to include window patterns, materials, colours, textures or significant changes in plane, that together, create visual interest.

assisted living — Where seniors live together but in separate units (rooms or apartments) owned by an organization (for-profit or not-for profit) and formal services are provided such as meals, recreational activities, transportation, and health care services.

C

Centre Street Bridge Demountable Flood Barrier — This is a temporary barrier that is constructed prior to a flood, and taken down after the flood. The supports are built into the bridge deck and when needed a temporary wall is assembled across the lower deck out of metal posts and panels that secure into the supports on the bridge deck.

Chinatown — Chinatown consists of approximately 24.76 hectares bounded mainly by the Bow River on the north, Macleod Trail S.E. on the east, mainly Second Street S.W. on the west, and Third Avenue S.W. to the south, with a bump-out extending one block south along Centre Street South and two blocks east across Fourth Avenue S.E. The neighbourhood boundaries also include the eastern portion of Prince's Island Park.

Chinese/Asian — A term that refers to China, East Asia and Southeast Asia for the purpose of reflecting the history and current ethno-cultural characteristics of Calgary's Chinatown.

climate adaptation — Climate change adaptation refers to actions, programs and tools intended to reduce negative impacts of climate change on built and natural infrastructure, economy and people.

climate mitigation — Climate change mitigation is taking action to reduce and prevent greenhouse gas emissions from going into the atmosphere or removing greenhouse gases from the atmosphere through natural or technological means.

colonnade — A series of regularly spaced columns providing load-bearing support of an overhead structure, such as an arcade.

community — A term to emphasize the bonds that link residents to each other and to the neighbourhood they call home, or to a group with which they share a common interest.

concept — A general notion or idea.

Council — The Council of The City of Calgary.

cultural reference — An important way to intensify the "look and feel" of Chinatown and promote continuity between the building and local character through character defining elements, or cultural expressions (such as culturally appropriate design, Chinese/Asian motifs and signage).

D

deep energy retrofit — A whole building analysis and construction process that aims to improve overall building energy performance by at least 40 per cent.

density bonus — A planning tool that allows an increase in density of development in exchange for providing public amenities that have a lasting public benefit as identified by the community.

design compatibility — The quality of being "contextual", respecting local character, human scale, activity level, materiality, pattern and rhythm of the streetscape or block face with designs that are complementary, compatible and will contribute to the overall quality of the neighbourhood. It does not encourage direct imitation of the past or radical departure from the existing context.

PROPOSED

BYLAW NUMBER 64P2022

Downtown Core — One of the neighbourhoods that make up Greater Downtown. This area is a prominent destination for business, entertainment, culture and events. It is an area of intensive high-rise, high-density development. Buildings in this area incorporate a mix of uses and may have access to the Plus 15 network.

E

experiential lighting — While lighting can serve more than one purpose, experiential lighting is designed primarily to enhance the environment, not to provide security. This can include lighting of buildings, monuments, public art or pathways. Source: Centre City Illumination Guidelines, 2011

G

gateway — Important transportation connections either to enter the city or to signify entrance into a specific part of the city. Well-designed entrances welcome people and provide a sense of arrival to an important place.

greenhouse gases — Refers to any gas in the atmosphere that absorbs infrared radiation, thereby trapping heat in the atmosphere.

green network — Refers to an interconnected system of regional and local parks, natural spaces and river frontage connected by high-quality people-focused streets (such as a High Street).

H

heritage resource — Includes heritage buildings, bridges, engineering works and other structures, as well as cultural landscapes such as heritage parks, gardens or streetscapes, culturally significant areas, Indigenous traditional-use areas and sites with archaeological or palaeontological resources. These can be managed by municipal, provincial or federal authorities.

high street — A street that responds to the special character of an area with historic resources or high density retail with concentrated pedestrian movement. It represents a model of the traditional main street with mixed-use, medium- to high-density developments that provide flexible transportation alternatives and comfortable, green, animated and safe pedestrian environments. The pedestrian realm must accommodate a full range of activities from retail to hospitality (patios), as well as other uses.

housing continuum — A visual concept used to describe and categorize different types of housing, from non-market to market housing. Housing continuums are developed to assist with planning and program development. Refer to Canada Mortgage and Housing Corporation's housing continuum, cmhc-schl.gc.ca.

I

imagineCALGARY — A two-year process initiated by The City and led by the community to create a 100-year vision for Calgary.

inclusion — An environment in which any individual or group is respected and valued, and supported to fully participate in society. In these environments people are included.

Inventory of Evaluated Historic Resources (Inventory) — A growing (non-exhaustive) list of sites that have been assessed by Heritage Calgary according to the Council-approved Historic Resource Evaluation System.

K

kiosk — A small structure in a public area used for providing information or displaying advertisements, often incorporating signage.

L

landmark sites — Prominent sites of high visual impact where buildings are — or would be — recognizable and contribute to wayfinding and placemaking for the neighbourhood. Landmark sites are rare within a neighbourhood and may include hilltops and terminating vistas. They may be buildings, structures such as bridges, memorials or public art. They may also be landscapes that have a special heritage, architectural or cultural significance.

landscaping (soft and hard) — The modification and enhancement of a site in any of the following ways:

- soft landscaping consisting of vegetation such as trees, shrubs, hedges, grass and ground cover
- hard landscaping consisting of non-vegetative material such as brick, stone, concrete, tile, wood and other material
- architectural elements consisting of sculptures and the like

lock-off or lock-out units — The design of dwelling units that permits a portion of the dwelling to be divided into two separate sections for the purposes of renting or accommodating additional family members.

low carbon energy supply feasibility study — An assessment prepared by qualified professionals that analyzes approaches to mitigate greenhouse gas and deliver low carbon energy to a proposed development over time. Analysis of technical options both at the site and building scale should be undertaken from a financial and environmental perspective.

PROPOSED

BYLAW NUMBER 64P2022

M

Mezzanine — An intermediate floor between main floors of a building, and therefore typically not counted with the overall floor count of a building.

Motifs — Decorative elements that are repeated across multiple buildings, scales and eras to create a broader identity.

Municipal Development Plan — The City of Calgary's vision for how the city grows and develops over the next 30 to 60 years.

multi-generational housing — The design of dwellings with accessibility, flexibility and the needs of larger families in-mind. Specific provisions include the creation of family-friendly (2 and 3 or more bedrooms) multi-unit housing that ensure adequate space that includes kitchen spaces, and appropriate number of bathrooms to accommodate all family members.

N

net zero — A target of completely negating the amount of greenhouse gases produced by human activity, to be achieved by reducing emissions and implementing methods of absorbing carbon dioxide from the atmosphere.

net zero buildings — Buildings that produce as much clean energy as they consume annually, using on-site renewable energy systems. They may have extra insulation, high performance windows and airtightness that minimizes heating and cooling needs. Appliances, lighting and mechanical systems are also energy efficient.

net zero ready buildings — Buildings that are built to the exact same efficiency level as net zero buildings, except that the renewable energy system (e.g. solar panels) have not yet been installed. These buildings are designed and constructed to easily install the renewable energy systems in the future.

P

pathway — A facility for use by walkers and wheelers for recreation and transportation purposes, but where motorized modes are prohibited. The regional pathway system is Calgary's city-wide linear network.

pedestrians — The term often used for people walking on the street, but it should also be used to include people with different levels of mobility, including disabled people.

The Plan — Refers to the Chinatown Area Redevelopment Plan.

Plus 15 network — A network of grade-separated pedestrian walkways and bridges, 15 feet above the road grade, which connects developments within Calgary's Downtown Core.

private realm — Consists of private space or buildings that are visually incorporated into the public realm and allows for limited or no physical access to the public.

projecting blade signage — A type of sign that is usually mounted perpendicular on the wall of a building, and is more oriented toward pedestrians.

promenade — A formally designed pedestrian-priority walkway along the riverfront that includes a walkway and urban features such as benches, garbage disposal and pedestrian-scale lighting.

R

recreation — The City of Calgary defines "recreation" as including sport, arts and culture, and physical and leisure activities.

retail — The sale of goods and services from individuals or businesses to the end-user.

riverfront — Refers to the area alongside the Bow and Elbow rivers.

S

screening — The total or partial concealment of a building, equipment, structure or activity by a berm, fence vegetation or wall.

servicing — The space and facilities used for the delivery and/or removal of material to a residential, retail or commercial property.

semi-private realm — Consists of the space between a building façade and a public sidewalk as well as any private spaces that may be accessible to the public such as the Plus 15 network or enclosed atriums/galleries. Semi-private space ties together linkages and built form in a comprehensive and connected public realm.

setback — An area measured as a distance from a public right-of-way or private lot line restricting building development.

shared micromobility — Shared-use fleets of small, fully or partially human-powered vehicles such as bikes, e-bikes and e-scooters. These vehicles are generally rented through a mobile app or kiosk, are picked up and dropped off in the public right-of-way, and are meant for short point-to-point trips.

PROPOSED

BYLAW NUMBER 64P2022

special care facilities — Facilities that provide for a broad range of specialized accommodation and care in order to meet a diverse array of neighbourhood needs, including uses in the Care and Health Group of the Land Use Bylaw such as nursing homes, daycares, adult group homes, youth care facilities, rehabilitative homes and transitional facilities. These facilities should be small scale in nature and in a form that fits with the neighbourhood character.

storey — The space between the top of any floor and the top of the next floor above it, or, if there is no floor above it, the portion between the top of the floor and the ceiling above it. It does not include a basement.

strategy — An expression of how and where efforts will be focused to achieve goals.

street level — The elevation of the street where it meets a building or open space interface.

street wall — The base height of a building that defines the vertical edge of the street it faces.

sunlight access — The siting of buildings, including podiums and upper building levels, to maximize sun exposure to adjacent streets, open space and building façade.

T

Tong House — A use which provides for a Chinese family affinity meeting hall and that may include the provision of rooming accommodation with shared washing and cooking facilities. Source: Bylaw number 99D2021.

traffic calming — The combination of mainly physical measures that reduce the negative effects of motor vehicle use, alter driver behaviour and improve conditions for non-motorized street users. Typical devices include traffic circles, curb extension, diverters and speed humps.

traffic signals — A traffic control device used to regulate the flow of vehicles, bicycles and pedestrians through an intersection.

transit service — Refers to all components (type of transit, routes, schedules, et cetera) of providing transit to residents, workers and tourists.

transit station area — The area surrounding a transit station along a primary transit line, such as a light rail transit or Bus Rapid Transit route, that includes enhanced amenities.

transportation demand management — Built facilities or ongoing initiatives that reduce single occupant vehicle trips, such as universal transit passes, secure bicycle parking facilities, showers and changing facilities for workers and/or carpooling incentives.

U

universal accessibility — Creating an environment with no barriers, so that all members of society can access the neighbourhood amenities and participate in the activities of the neighbourhood.

urban design — The practice of giving form, shape and character to the arrangement of buildings, neighbourhoods or the city as a whole. At the more detailed level, it involves shaping the external spaces between buildings and designing their detail and finishes to respond to use, context, climate and building form.

utilities — Facilities for gas, electricity, telephone, internet, television, water, and storm or sanitary sewer.

V

view corridors — Defined and discrete views from one point to another point. These may include, for example, views of the Calgary Tower from Centre Street S. or views of the Rocky Mountains from Nose Hill.

vulnerable groups — Groups of people at a higher risk for poor economic and individual health because of social, economic, political and environmental circumstances, including barriers such as illness and disability.

W

walkways, pedestrian — Principally a public linkage for pedestrians only — a right-of-way or easement.

PROPOSED

BYLAW NUMBER 64P2022



A Appendix

附錄

附录

Appendix A: Planning and engagement process

Project evolution

In 2016, The City led extensive engagement regarding the future of Calgary's Chinatown. This work highlighted concerns about the erosion of the unique cultural identity and viability of Chinatown, including but not limited to programming and investments for the built environment. In the summer of 2018, City Council was unanimous in their support to proceed with the first ever, area-based cultural plan for Calgary's Chinatown that would inform a new area redevelopment plan. Council's direction gave way to a multi-year program of projects known as Tomorrow's Chinatown.

Tomorrow's Chinatown Program

Tomorrow's Chinatown was a collaborative program of projects that facilitated working together with community members. The program included three projects: **Chinatown Area Redevelopment Plan**; **Chinatown Cultural Plan**; and, renaming of the former James Short Park and Parkade. The focus of the **Chinatown Area Redevelopment Plan** project was to prepare a new culturally informed area redevelopment plan to ensure that Chinatown thrives as a vibrant, culturally rich place to live, visit, work and do business for generations to come.

The analysis, planning and engagement process for the **Chinatown Area Redevelopment Plan** project spanned over three years in collaboration with the Chinatown Advisory Group and many other community members. While context and public input are an important aspect of policy formulation and part of any planning process, other contributions played a significant role in influencing the content of this Plan by offering different analysis and perspectives.

Contributing influences

Sources of input for the Plan include:

- Chinatown Advisory Group
- Community and public engagement feedback
- **Chinatown Cultural Plan**
- **Chinatown Historical Context Paper**, The City of Calgary in collaboration with Heritage Calgary (formerly Calgary Heritage Authority) and The Chinatown Heritage Project - including Heritage Buildings Could Talk: Beyond dim sum, lion dances and empty parking lots, led by 馬鳳齡 Fung Ling Feimo and produced by Heritage Calgary.
- **The Inventory of Evaluated Historic Resources**, Heritage Calgary
- Three Urban Alliance academic research projects:
 - **Identity and Culture in Calgary Chinatown**, by Dr. Matt Patterson, Lindsey Kokaritis, Jacey Magnussen and Jason Yip, University of Calgary, Urban Alliance.
 - **Chinatown Mobility Study: Evaluation of Transportation Network and Market Condition**, prepared by Dr. Kwangyul Choi, University of Calgary, School of Architecture, Planning and Landscape, The Urban Lab.
 - **Chinatown Sense of Place Survey**, led by Francisco Alaniz Uribe, University of Calgary, School of Architecture, Planning and Landscape, The Urban Lab, Sept. 10, 2021.
- Calgary Chinatown-Artist-In-Residency
- Technical analysis
- Chinatown Lunch and Learn sessions
- Landowner / Developer / Industry sessions

The process

Discover

In the Discover Phase, we engaged with the community to understand Chinatown's cultural values, the community's vision for future development, and how those two things intersect. We reached out to residents of Calgary to discover their hopes for the Chinatown of tomorrow.

Create

In the Create Phase, we had deeper conversations with the community about what the major opportunities and priorities are that should drive the future planning of Chinatown. In conversations focused on specific topics, we discussed what the Plan should aim to achieve with its policy direction.

Realize

In the Realize Phase, we synthesized all that we learned from the engagement process to develop a vision, core ideas and planning policies to help guide future development in the neighbourhood. The result was the completion of the Plan and launch of its implementation.

Who we reached

 **19,000+** people visited the calgary.ca/Chinatown webpage

 **1,500+** surveys filled out with **1,300+** individual contributions

Engagement overview

Multi-year public engagement was integral to the preparation of this Plan. It focused on understanding the Chinatown community and area, and looking at many factors that impact the neighbourhood. Tomorrow's Chinatown sought local and city-wide input from citizens to develop the planning goals for Chinatown. This was to ensure that the needs, priorities and local knowledge are represented in this Plan and that future actions in the neighbourhood will be successfully implemented.

Engaging the community using inclusive engagement

The engagement level for this project was 'Consult' which can be explained as follows: we will consult to obtain feedback and ensure their input is considered and incorporated to the maximum extent possible. We will endeavour to inform how consultation impacted the decisions and outcomes.

To enable participants to effectively contribute to the process, the project started with an educational focus to increase knowledge about planning and development. This included conversations on how cultural planning can benefit the planning process. Community members were consulted on the project's scope and information was shared on how an area redevelopment plan fits into our city-wide goals. A plain language and transparent communications approach was consistently applied in our materials. Additionally, facilitation and providing equal and accessible opportunities to participate in all aspects of outreach and engagement were provided.

Engaging the community using an inclusive engagement process required a tailored approach.

This was achieved through:

- Prioritization of translating all engagement portal content into Traditional and Simplified Chinese;
- accommodation and provision for translation services in real-time (virtually) for focus groups;
- collaboration with senior's service agencies to ensure that senior's voices were heard and included;
- communications and marketing initiatives that included radio, print and online advertising and social media in Traditional and Simplified Chinese to draw attention to engagement opportunities;
- in-community advertising through community newsletters, posters, addressed mail and street signage;
- co-hosting events with community organizations, including events in Cantonese and Mandarin;
- streamlining engagement by coordinating various projects through the "Chinatown Engagement Days" event series;
- distributing Lunar New Year greeting cards to the community to celebrate the important cultural holiday; and,
- paying honourariums to panelists and community interpreters.

Engagement during a pandemic

In March 2020, The City coordinated a local response to the COVID-19 pandemic and a State of Local Emergency was declared. During the course of the pandemic, a combination of public health orders, restrictions and general guidance made in-person engagements unfeasible. As such, all in-person public engagement between March 2020 and March 2022 was suspended.

Public engagement for this Plan took place from June 2020 to June 2022. Much of the engagement was conducted online via The City's engagement portal and through virtual meetings. Input from all engagement was considered by the project team during the formulation of the Plan.

Community relations in Chinatown

In mid-2021, The City established a community relations role to support the large scope and high intensity of work in the community. This role played an integral part in enhancing our relationship with the Chinatown community. It also helped maintain coordination between all Tomorrow's Chinatown projects. Some key functions of this role were:

- Internal coordination: bringing together cross-corporate project and communication teams to encourage coordination, streamlined communications, and mitigate conflict.
- Building trusting relationships: building relationships with communities through enhanced community presence, responsiveness, and demonstrating an understanding of community interests.
- External events and communication: coordinating communications, project work, and engagement to reduce fatigue, boost efficiency, and align with community interests.

Tomorrow's Chinatown Advisory Group

One of the foundational pieces of the Tomorrow's Chinatown program engagement included the recruitment of the Tomorrow's Chinatown Advisory Group. The Advisory Group (AG) was designed to accommodate those community members with more committed interests and more time to offer to the program; where we could have more technical conversations, a deeper dive into both cultural and planning matters and build off the knowledge gained at each session.

The purpose of the AG was to advise and work with The City's program team to develop the **Chinatown Cultural Plan** and the Chinatown Area Redevelopment Plan; and to provide support and advocacy for the Tomorrow's Chinatown program within respective community networks. The AG served as a sounding board to The City's project team and participated in more detailed dialogue about the broader planning interests of Chinatown with a focus on big ideas and actions/opportunities for future growth. In total there were (15) formal AG meetings held since June 2020.

The AG is comprised of a broad range of community members and has 25 members. Membership is comprised of:

- Three (3) members representing the general community;
- one (1) member from the Calgary Chinatown Community Association;
- one (1) member from the development industry;
- two (2) members from the Chinatown Business Improvement Area;
- four (4) members from arts and culture organizations or affiliated with post-secondary institutions;
- nine (9) members from a religious or ethno-cultural organization or society;
- two (2) members from a healthcare, education or social service agency; and,
- three (3) members representing youth, sports, fitness, recreation or tourism organization.

Appendix B: Climate risk profile

Chinatown

Chinatown, like all neighbourhoods in Calgary, will experience impacts of climate change. The City of Calgary is creating climate risk profiles to provide a detailed understanding of climate change risks and opportunities to create climate resilience in each community in Calgary.

Climate risk is determined by three factors:

- **Climate change hazards:** Events made more intense and/or frequent by climate change that may cause loss of life, injury, health impacts, damage to property, livelihoods, services, and the environment.
- **Exposure:** The presence of something of human value in a place that could be impacted by a climate change hazard.
- **Vulnerability:** The characteristics of a place and people that make hazards more impactful.

A risk score is assigned to each community, which reflects the relative risk of climate change in that community compared to others in Calgary.

Risk is assessed for both the present and 2050. Risk in Chinatown is below the city average but is expected to rise significantly by 2050.

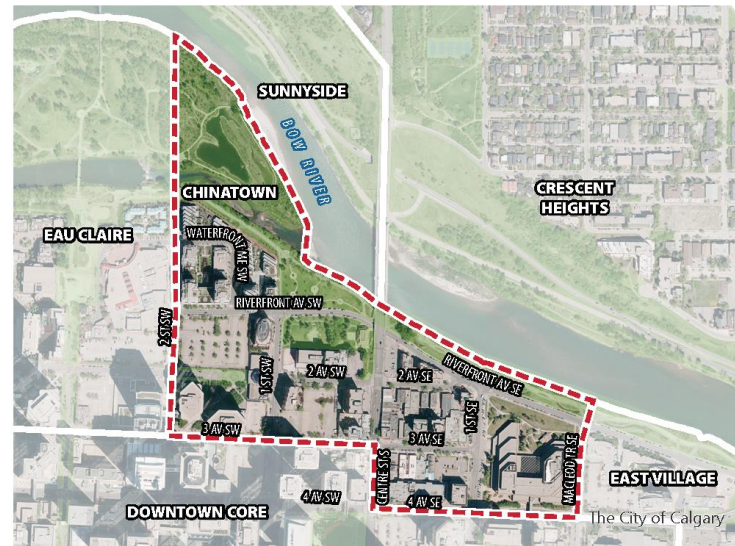

Legend

- Chinatown Area Boundary

PROPOSED

BYLAW NUMBER 64P2022



Sources of Vulnerability



Social Environment

Social vulnerability to all climate hazards in Chinatown is relatively low and driven by:

- a comparatively older population;
- relatively high concentrations of single person households;
- community members who do not speak English or French at home; and,
- low-income households.

Chinatown's presence as an established mixed-use area may provide some protection from climate hazards as residents can access critical services and providers within their neighbourhood.



Built Environment

Built systems in Chinatown are moderately vulnerable to all climate hazards due to the amount of paved land, age and condition of dwellings and age of stormwater infrastructure. Transportation, infrastructure and park assets are in close proximity to the Bow River and may be impacted by flooding. Major flood works to protect the neighborhood were under construction in 2021.



Natural Environment

Natural systems in Chinatown are highly vulnerable to climate hazards, particularly extreme heat, river flooding and heavy rainfall. This is due to the poor health of some parks, riparian areas and public trees.

What are we doing about it?

Climate resilience direction within The Plan related to new development, major renovation, and redevelopment projects should:

- Include climate resilient features like cooling systems, green roofs, and permeable native landscaping
- Exceed minimum landscaping requirements for trees and soft surfaced areas to reduce extreme heat and stormwater flooding
- Not destroy healthy trees on public or private lands
- Incorporate back-up renewable power generation
- Include affordable housing units

PROPOSED

BYLAW NUMBER 64P2022

Community Climate Risk Score

A Community Climate Risk Score is a relative ranking system for climate risk across all communities in Calgary. The index includes exposure, vulnerability, and risk scores for six climate hazards (meteorological drought, higher average temperatures, extreme heat, severe storms, river flooding, and short duration high intensity precipitation). The index can be used to find the highest risk communities and compare levels of risk across communities.

Climate Risk Score

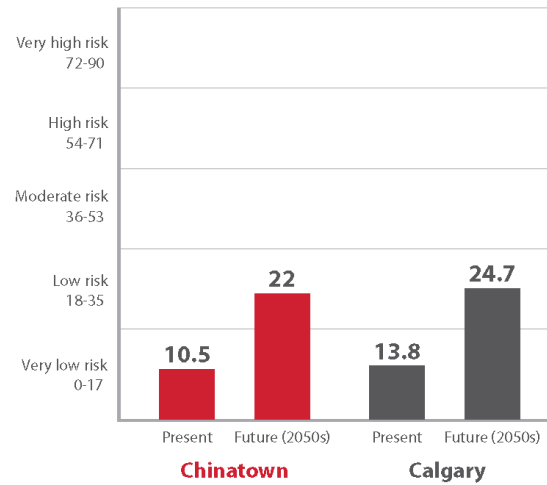

Top climate hazards for Chinatown



River flooding

Floods will become more frequent due to climate change



Extreme heat

Climate change will result in more frequent, longer, and intense heatwaves



High intensity precipitation

Climate change will result in more intense rain and snow events that can cause floods

Appendix C: Public realm strategy

Overview and objectives

To sustain and grow Chinatown's vitality, there must be public realm improvements that reflect the community's history and cultural presence. Chinatown's prime location in proximity to the river, transit and offices are great assets. However, what sets Chinatown apart from any other neighbourhood is its cultural identity and unique historic resources. As any older neighbourhood, it is challenged by aging infrastructure and space in the road rights-of-way for the needs of everyone. Chinatown will continue to evolve over the coming decades. Investment in the public realm and infrastructure will impact the future success of Chinatown as a place where people want to live, visit and set up businesses.

The following objectives are intended to guide decisions for public realm improvements in Chinatown:

- Facilitate social connections through access to a variety of great places.
- Reinforce the unique identity, culture and history of Chinatown through architecture, art, signage and any other public or private realm redevelopment.
- Improve safety and comfort for all ages and abilities to enjoy public places.
- Improve the mobility experience to support all travelers.
- Celebrate, protect and enhance heritage assets.
- Strengthen neighbourhood gateways, edges and landmarks.
- Leverage community partnerships to ensure redevelopment, infrastructure projects and programs contribute to the vision for Chinatown.

The actions outlined in this section provide high-level, neighbourhood-wide options to get to the future envisioned in The Plan. The identified actions represent opportunities that were identified through public engagement conducted over the duration of the Tomorrow's Chinatown program.

Proposed actions in this section could also provide high-level, strategic direction to inform investment decisions. Further detailed analysis and study for each option identified will be required and require engagement with area residents and community members as appropriate.

This section is intended to be revised over time as local growth occurs, actions are evaluated or completed and/or new options are identified through subsequent community engagement and City departmental prioritization.

Strategic direction

Chinatown has distinctive features and opportunities that informed the proposed future actions in this section. To achieve Chinatown's vision and core ideas, there must be sustained action in each of the following areas: placemaking; the green network; and, mobility.

Placemaking

Chinatown has several special places; however the opportunity exists to enhance the public realm and these places to support the culture and heritage of the neighbourhood to meet the needs of the community.

Culture

- Implement an overhead lantern program.
- Provide better wayfinding signage that is multilingual for people walking and wheeling to and through Chinatown, especially at public transit system stations close to Chinatown.
- Support a façade improvement program in Chinatown to provide an incentive for beautification and restoration of business frontages.
- Support the use of murals on private property that depict the history of Calgary's Chinatown and aspects of Calgary's Chinese/Asian culture.
- Contribute towards efforts to archive, curate, transfer and store documents, images and videos from Tong Houses and other neighbourhood-based cultural organizations that add to the history of the neighbourhood and the overall city.

Heritage

- Adopt new funding and incentive roles to ensure that the appreciation of heritage value does not lead to the displacement of — but instead new opportunities for — cultural groups, programs and activities.
- Explore how the Canton/Ho Lem Blocks, National League Hall and other historical spaces can be revived with experiences, neon signs and art works in the alleyway and façades and rooftops.
- Explore the (re) naming of sites, streets and buildings to better reflect or interpret the area's heritage.
- Consider cultural reference in the implementation of public and commemorative art.
- Explore ways to increase awareness and appreciation of Indigenous heritage in the Chinatown area, including through collaborative artwork and interpretive features. Celebrate the relationships and friendship between the Chinatown community and Indigenous Peoples, such as at or near the site of the former Friendship Centre.

Cultural Centre

- When opportunities exist, enhance the Calgary Chinese Cultural Centre as the most prominent landmark in Chinatown by incorporating innovative design and placement of signage and lighting on the building façades, as well as street interface improvement adding character defining elements, without compromising the integrity of the iconic building.
- The public realm west and east of the Calgary Chinese Cultural Centre should be upgraded with new infrastructure, utilities and street furniture and lighting to facilitate vibrant streets and plazas that accommodate cultural events in all seasons.

Gateways

- New gateway or landmark enhancement features should be supported at strategic locations to encourage pride and identity and strengthen the edges of Chinatown, while providing character and scale transition between Chinatown and adjacent neighbourhoods.

PROPOSED

BYLAW NUMBER 64P2022

Alleyway activation

- When opportunities exist, privately-owned undeveloped spaces behind heritage resources labeled #1 and buildings along 2 Avenue S.E. labeled #2 in Figure 20 should be explored as potential 'alleyway' gathering spaces. An informal space (labeled #1 in Figure 20) has already benefited from community-level activation with public art and interpretive historic features and demonstrates potential for enhanced activation of this and/or other 'alleyway' spaces as gathering places with small business integration.
- If supported by impacted property owners, The City should explore further opportunities to support one or more publicly accessible 'alleyway' spaces in the Heritage Core character area, including improvements to safety, lighting, pedestrian connectivity, usage and placemaking.
- In collaboration with impacted property owners, The City should investigate available resourcing that could be used to reach a consistent access agreement or fund required upgrades.

Green Network

Chinatown's publicly accessible private and public open spaces and associated amenities provide important benefits to the residents and wider community. These are places where residents gather, celebrate, learn and play. Continued support and investment in these facilities is necessary to allow them to continue to thrive. Action should be taken in the following areas:

General

- Calgary's Greater Downtown Plan outlines a network of parks and open spaces that are part of the green network. As these build out, the green network grows. This includes improved connections to the Bow River, urban plazas and Sien Lok Park.
- As the population of Chinatown increases, The City should investigate opportunities for acquisition of additional land for parks, arts, culture and recreation purposes. Additional open space acquisition may occur through donation, land purchase, or other means (such as public access easements).
- Assess and upgrade public lighting along the river pathway system and other Chinatown parks and alleys as needed to ensure user safety and usability at night.
- Amend the Land Use Bylaw to make consistent the sunlight protection rules for the riverbank promenade throughout the Greater Downtown area and add sunlight protection rules for Sien Lok Park.
- Support restoration of native habitat within natural areas to enhance ecological connectivity and carbon sequestration potential.
- Support a Chinese-inspired garden design.

Sien Lok Park

Sien Lok Park is a significant cultural landmark and key open space resource in Chinatown. It connects directly to the Riverbank Promenade and is an important gateway into the neighbourhood from adjacent areas. It is a reminder of Chinatown's historic resilience and should be a significant hub for the neighbourhood. To beautify, activate and increase the cultural significance of the park, the following actions should be considered:

- Support the planned enhancements to Sien Lok Park.
- Improve the road crossing between both sides of the park.
- Allow uses which activate the park such as temporary food stalls or temporary sales stalls.
- Identify funding for capital upgrades to Sien Lok Park and the adjoining open spaces.
- Support culturally inspired amenities (from the **Chinatown Cultural Plan**).
- Retain public art that expresses Chinatown's history and culture.
- Enhance the cultural character by incorporating traditionally inspired, contemporary garden design elements (e.g. featured entrance gateway, meandering pathways, seating areas, gathering hubs, interactive public art, play zones, experiential lighting, featured spaces for programming, virtual storytelling components, etc.).

PROPOSED

BYLAW NUMBER 64P2022



Chinatown Cultural Plan

—
There is opportunity for a stronger (funding) relationship between the Cultural Centre and City of Calgary, based on a renewed vision, and working as close partners on promotion, programming and facility upgrades.. — **Action B3.3**

—
Centre Street S. requires a full rethink to no longer act as a divider. — **Action E1.2**

Mobility

Mobility infrastructure is a critical element of a public realm strategy. How people move and/or linger in the public realm significantly impacts the vitality of a neighbourhood.

Centre Street S.

- Centre Street S. acts as a neighbourhood divider, but with the right improvements, could be a neighbourhood connector.
 - Develop strategies to re-knit the urban fabric, connect people to and through the neighbourhood and improve accessibility and permeability for all modes of transportation.
 - Increase signal timing and explore intersection improvements along Centre Street S. to give pedestrians more time to cross.
 - Allow additional space in the public right-of-way to enhance pedestrian amenities.
 - Support the progression of transit priority in the corridor to transition from the current peak direction lane reversal to dedicated transit-only lanes.
 - Explore additional bollards or planters at the northwest corner of 4 Avenue S. and Centre Street S. to increase pedestrian safety from errant vehicles.
 - Improve the curb radius to slow right hand vehicle turning movements and improve pedestrian safety at the southwest and northeast corners of Centre Street S. at 2 Avenue S.

3 Street S.

- Replace jersey barriers dividing the sidewalk from vehicle lanes with a safe and attractive alternative that uses a smaller footprint.

Parking

- Chinatown is an ideal location to pilot innovative parking strategies as well as curbside management initiatives that aim to make more efficient use of constrained spaces.
 - Conduct a thorough review of parking in the area to determine the needs and utilization.
 - Explore technology that supports smart parking and city-led initiatives for curbside management.
 - Pilot innovative on-street loading and curbside management initiatives to improve the effectiveness and efficiency of loading in dedicated vehicle parking stalls.

Connections

- Provide a network of pedestrian and bicycle facilities that will link the open space network to the surrounding neighbourhoods, the regional pathway and citywide park and open space system.
- Conduct a thorough review of wayfinding signage for Chinatown.
- Provide wayfinding signage to identify all gateways, parks and open spaces and other public gathering places as necessary.
- Re-establish of the urban grid through the Harry Hays site.

Zero carbon neighbourhoods

- Continue to:
 - engage with utility companies to enable the deployment of alternative energy sources, including, but not limited to solar photovoltaic, geothermal and District Energy; and,
 - work on developing incentives to offset the costs associated with developing buildings that exceed the energy code minimum requirements.
- Promote mobility infrastructure investments that support:
 - improved air quality and reduced transportation-related greenhouse gas emissions;
 - vibrant public space and street designs that encourage active, low carbon travel options including walking, wheeling and biking; and,
 - deployment of car sharing programs, low-carbon and electric vehicles.

PROPOSED

BYLAW NUMBER 64P2022

Figure 19: Chinatown strategic investments

Projects – Completed, underway, designed

Park / Plaza Projects

- (A) Eau Claire Promenade

Streetscape Enhancement

- (B) Centre Street from Bridge to 4 Avenue S. conceptual design
- (C) 3 Avenue S. walking and wheeling upgrades

Project and Programs

- (D) North Central BRT and dedicated transit lanes on Centre Street
- (E) Future LRT Station at 2 Avenue S.W.
- (F) Downtown flood barrier and Eau Claire Promenade

Projects – Future

Park / Plaza Projects

- (G) Sien Lok Park upgrades
- (H) Centre Street and 2 Avenue S.W. enhance gateway feature and open space
- (I) 4 Avenue S.E. and Centre Street improve and enhance plaza space and transit stop/station area
- (J) Enhance the Calgary Chinese Cultural Centre

Streetscape Enhancement

- (K) Centre Street between 2 and 4 Avenue introduce overhead gateway features
- (L) Centre Street S. and 4 Avenue S. repurpose parking to increase the public realm and potentially BRT station
- (M) Centre Street between 2 and 3 Avenue increase and enhance the pedestrian space
- (N) 1 Street S.W. activation
- (O) Potential green network upgrades

Project and Programs

- (P) Heritage Core Alleyway Activation Program
- Develop a consistent furniture palette that incorporates cultural references with ample seating opportunities (all streets in Chinatown).



The illustration is for conceptual purposes only.

PROPOSED

BYLAW NUMBER 64P2022

Figure 20: Alleyway opportunities



The illustration is for conceptual purposes only.

Spotlight

The illustration above imagines the future of the alleyway in the Heritage Core area. Privately-owned undeveloped spaces behind buildings along 2 Avenue S.E. should be explored as potential 'alleyway' gathering spaces. An informal space (item 1) has already benefited from activation with public art and interpretive historic features. There is potential for further enhancements and activation.

The future alleyway enhancement and activation needs:

- a. Property owner support and involvement for public accessibility.
- b. Improvements for safety, lighting, pedestrian connectivity, usage and placemaking.
- c. Parking alternatives for business owners.
- d. Regular cleaning and maintenance.

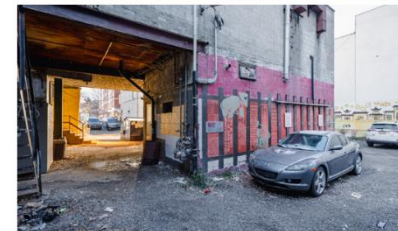

Appendix D: Regional Corridor and Context Map

The Calgary Metropolitan Region Growth Plan (Growth Plan) identifies regionally significant corridors and placetypes. This Plan is aligned with the Growth Plan as shown in Maps 6 and 7. Map 6 (p. 109) identifies regionally significant corridors including mobility corridors and transmission corridors. Map 7 (p. 110) shows the Plan area that is predominantly categorized at the Infill and Redevelopment Placetype. Placetypes are elements of the Growth Plan that describe generalized land use categories at a regional level.

PROPOSED

BYLAW NUMBER 64P2022

Map 6: Regional corridors and context map

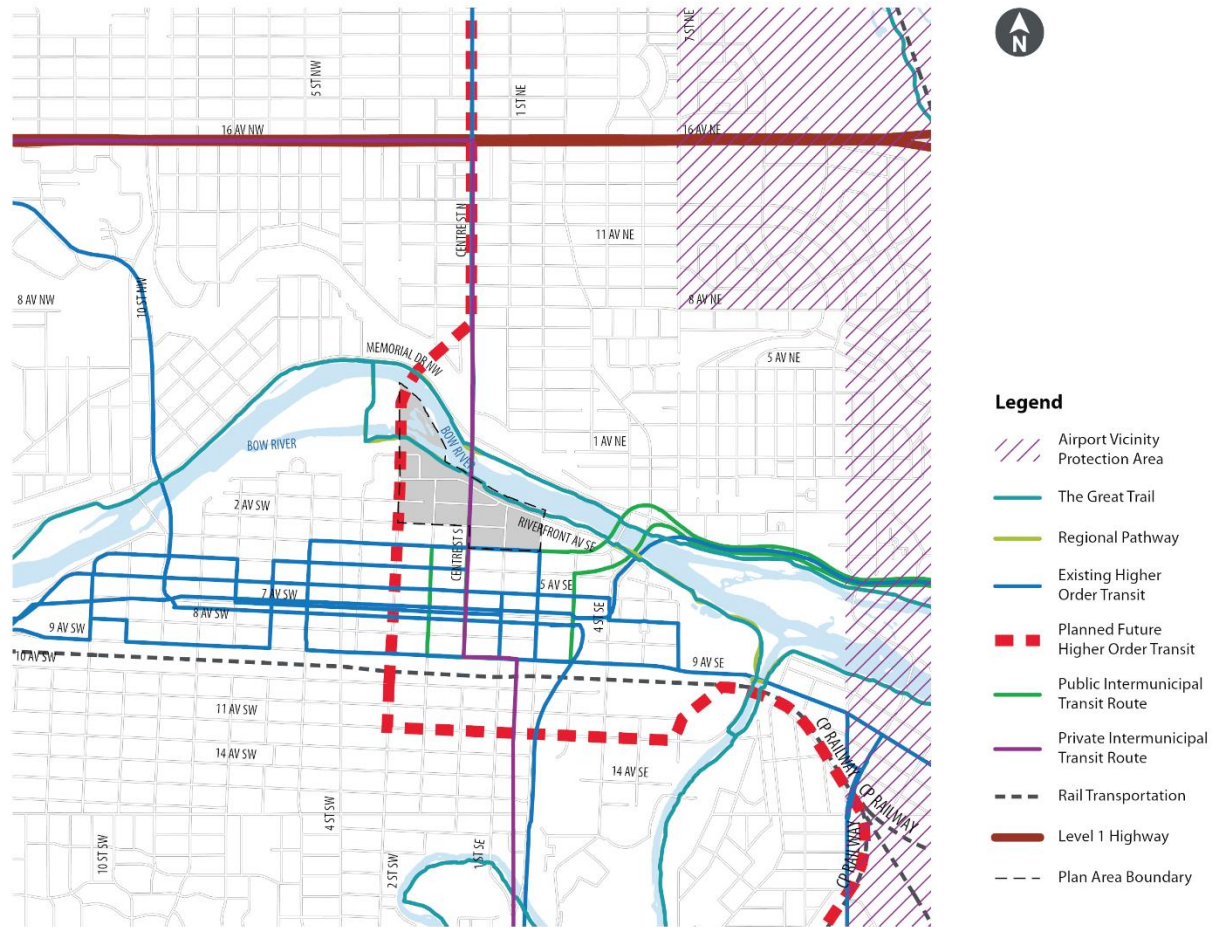

PROPOSED

BYLAW NUMBER 64P2022

Map 7: Growth plan placetype alignment

