



# Access Design Standards

## Advisory Committee on Accessibility

*Mobility, Vision, Cognitive, Hearing*

We gratefully acknowledge the following groups and individuals for their assistance with developing and revising content for the Access Design Standards 2016.

---

**The City of Calgary committees**

Advisory Committee on Accessibility  
Access Design Sub-Committee

**The City of Calgary business units  
and divisions that participated in  
developing the 2016 Standards.**

**Private industry/non-profit/  
individual contributors**

Accessible Housing Society  
Cerebral Palsy Association in Alberta  
Deaf & Hear Alberta  
Canadian National Institute for the Blind (CNIB)

**Editorial team**

Christina Budnick  
Ulrik Seward  
Patrick Sweet





## Overview

Disability<sup>1</sup> impacts the lives of many Calgarians. Statistics Canada's most recent (2012) Canadian Survey on Disability reports that 12.5 per cent of Calgary's population has a disability. This number is expected to increase as the population ages. In the 30-year span from 2012–2042, the disabled population aged 65 or older is expected to triple, from approximately 100,000 to over 300,000. For the first time ever, by the early 2030s Calgary will have more seniors than youth.

An inclusive society is one in which every citizen is welcome to participate in all aspects of everyday life in the community. To be inclusive, the built environment has to be accessible to all citizens.

The City of Calgary values all members of its diverse communities, and is committed to removing barriers that might prevent people with disabilities from fully participating in employment and all City programs and services

We're demonstrating leadership in accessibility. Calgary's City Council Advisory Committee on Accessibility supports integrating universal design into new developments and projects so that environments are useable, functional and accessible to everyone.

Together with the Access Design Sub-committee, the Advisory Committee on Accessibility focuses on broad policy issues and advises City Council on access and disability matters. The Advisory Committee on Accessibility reviews and recommends the optimal level of accessibility for all City services and projects, and reports through the Standing Policy Committee on Community & Protective Services.

The Advisory Committee on Accessibility welcomes questions regarding the content of these Standards and/or project consultations. These can be directed to the following:

### **Advisory Committee on Accessibility**

#### **Administrative Contact**

**Telephone: 3-1-1**

**TTY: 403-268-1379**

**Email: [ACA@calgary.ca](mailto:ACA@calgary.ca)**

---

<sup>1</sup> Disability is classified as physical or mental. The Alberta Human Rights Act (2000) defines a physical disability as "any degree of physical disability, infirmity, malformation or disfigurement that is caused by bodily injury, birth defect or illness. Some disabilities that have been established as protected under human rights law are: epilepsy/seizures, heart attack/heart condition, cancer, severe seasonal allergies, shoulder or back injury, asthma, Crohn's disease, hypertension, hysterectomy, spinal malformation, visual acuity, colour blindness, loss of body parts such as fingers, speech impediments, arthritis, muscular atrophy, cerebral palsy, alcoholism, and drug dependence." Mental disabilities are defined by the Act as "any mental disorder, developmental disorder or learning disorder, regardless of the cause or duration of the disorder. Some examples of mental disabilities include: dyslexia, depression, schizophrenia, obsessive compulsive disorder and panic attacks."



# Contents

## A. Vehicular access

Parking areas.....	6
Passenger loading zones.....	8
Signage.....	9

## B. Exterior paths of travel

Paths of travel.....	10
Obstructions.....	11
Benches.....	13
Curb ramps.....	13
Ramps.....	15
Patios/balconies.....	16
Parks.....	17
Crime Prevention Through Environmental Design.....	18
Accessible pedestrian signals at signalized crossings.....	18

## C. Building entrances

Entrances.....	20
Service dog relieving areas.....	22
Plus-15 skywalks.....	23

## D. Interior paths of travel

Paths of travel.....	24
Doors and doorways.....	26
Stairs.....	27
Handrails.....	28
Ramps.....	28
Elevators.....	28
Areas of refuge.....	29

## E. Washrooms

General.....	32
Washroom entrances.....	33
Washroom fixtures.....	33
Universal washrooms.....	35
Accessible portable toilets.....	35

## F. Special interior features

Controls.....	36
Faucets.....	37
Counters.....	37
Furniture.....	37
Drinking fountains.....	38
Public communications.....	38
Transactions.....	38
Assistive listening devices.....	39
Signage.....	40
Building directional maps.....	41
Pay telephones.....	41
Exhibits.....	42
Illumination and acoustics.....	43

## G. Buildings with special requirements

Places of assembly.....	44
Recreation facilities.....	45
Universal dwelling units.....	49
Calgary Transit.....	52
Construction sites.....	53

# About the Access Design Standards

The City of Calgary's Access Design Standards are intended to increase awareness of the needs of people with disabilities within the built environment. Written to complement the Alberta Building Code, these Standards aim to promote accessibility throughout City of Calgary facilities. They outline measures that exceed the requirements of the Code.

For more information on the Alberta Building Code's requirements for barrier free design, consult the latest edition of the *Barrier-Free Design Guide*, an Alberta Government publication. Another recommended resource on accessible design is The Canadian Standards Association Standard B651-12 Accessible Design for the Built Environment. (CAN/CSA B651-12).

## Application of these Standards

These Standards must be incorporated into the design and construction of all new buildings constructed on City-owned land. This includes facilities owned and operated by The City of Calgary (e.g. Village Square Leisure Centre) as well those built on City-owned land but operated by another organization (subject to lease agreement terms, e.g. Trico Centre). When The City leases space in buildings that are not on City-owned land, the leased space must also comply with the Access Design Standards (subject to landlord approval).

The Access Design Standards apply to City renovation projects as well. Ideally, the Standards should be fully applied during renovations. Please consult with the Advisory Committee on Accessibility before and during renovation projects to determine the level to which the renovation must comply with these Standards. The Standards do not apply retroactively to existing City facilities that are not undergoing renovations.

The Access Design Standards are intended for City-owned facilities or leased space for City use. That being said, design professionals, the building industry, government departments and the community as a whole are encouraged to implement these Standards in all projects constructed within The City of Calgary.

When working with the Alberta Building Code, it is possible to obtain a relaxation from the Province of Alberta. This would apply where compliance with the barrier-free requirements of the Code are unfeasible or unnecessary. These Standards require designers or any person(s) responsible for a project to consult with The City's Advisory Committee on Accessibility prior to seeking a relaxation from the Province.

## Rooted in experience

The City of Calgary's Access Design Standards exceed the existing Alberta Building Code requirements. Some Standards are reinforced with photography and graphic illustrations to support the information provided. All measurements in illustrations are in millimetres, unless otherwise specified.

The Standards are based on:

- Lived experience and knowledge of Calgarians with disabilities.
- Alberta Building Code.
- Expertise acquired by The City of Calgary business units through the planning and review of major projects.
- Standards in other municipalities, provinces and countries.

## How the Standards are organized

The Standards are organized into sections A – G.

- A. Vehicular access
- B. Exterior paths of travel
- C. Building entrances
- D. Interior paths of travel
- E. Washrooms
- F. Special interior features
- G. Building with special requirements

Where applicable, each section also includes the following subsections:

Alberta Building Code 2014 references

Articles of the Alberta Building Code and other recognized standards (i.e. Canadian Standards Association) relating to each requirement are referenced in this manual.

Where applicable, explanations or additional notes are provided.

## Updates to the Standards

Please visit [calgary.ca/accessibility](http://calgary.ca/accessibility) for the electronic and most up-to-date version of the Access Design Standards.





## A. Vehicular access

Accessible vehicular access, parking stall location and design, and effective signage allow people with disabilities to travel to a venue by car or transit vehicle. This section discusses The City of Calgary's Access Design Standards for accessibility as they relate to vehicular access on the property of City-owned buildings and facilities only. Calgary Roads should be consulted on all matters concerning public roads and sidewalks.

### Alberta Building Code 2014 references

- A-3.8.1.2. Entrances
- 3.8.2.2. Access to Parking Areas and Stall Design
- 3.8.1.3. Barrier-Free Path of Travel
- 3.8.3.1. Accessibility Signs
- 3.8.2.1. Areas requiring a Barrier Free Path of Travel

#### This Section covers:

- Parking areas
- Passenger loading zones
- Signage

### Parking areas

1. Accessible parking shall be located within 50 metres of barrier-free building entrances.

Explanation: Close access to barrier-free building entrances provides safe and convenient access for persons with limited mobility. To qualify for an accessible parking pass an individual must be unable to walk more than 50 metres unassisted.

Figure A.1.a

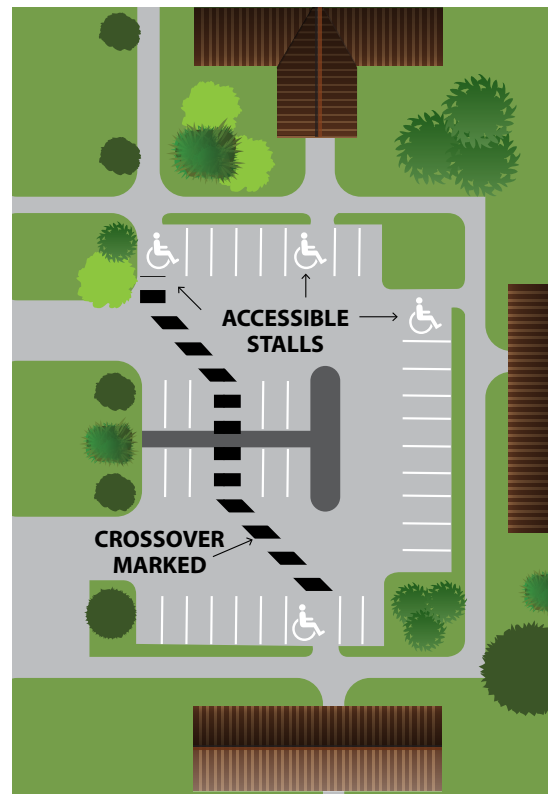

Figure A.1.b



2. Parking stalls for people with disabilities, and the access aisles adjacent to them, shall be paved.

Explanation: A paved (i.e. hard surfaced) stall and access aisle make it easier for someone with a disability to disembark from a vehicle and travel to the building entrance.

3. Parking stalls for people with disabilities shall be located adjacent to sidewalk curb ramps.

Explanation: A curb ramp allows for safe and easy travel to and from barrier-free paths of travel. The curb ramp shall be designed in accordance with Section B 34 - 41 of these Standards

4. Parking stalls shall be designed so that vehicle bumpers or other obstructions do not encroach on the barrier-free path of travel, regardless of the width of the path of travel.

Explanation: The Alberta Building Code 2014 3.8.2.2.(4) (e) is a performance requirement intended to prevent vehicles from being parked in a manner that the front of the vehicle overhangs a barrier-free path of travel. One way to achieve this is by providing wheel stops set back from the barrier-free path of travel such that vehicle bumpers cannot encroach onto the barrier-free path of travel.

5. Parking areas shall be designed so that people with disabilities do not have to pass behind other parked vehicles.

Explanation: This design increases the safety of persons using a manual wheelchair or other manual assistance devices such as walking aids, including canes, crutches, braces and artificial limbs. One way to achieve this is to have the accessible parking stalls located adjacent to a walkway that leads directly to the accessible entrance. In this case, an access aisle and curb ramp will lead directly from the parking stall onto the walkway.

6. Street parking stalls for persons with disabilities shall be located adjacent to sidewalk curb ramps.

Explanation: Curb ramps provide safe and convenient access to barrier-free paths of travel and building entrances. Current City practice does not support mid-block ramps. The location of stalls and ramps should be considered for block ends.

Figure A.3

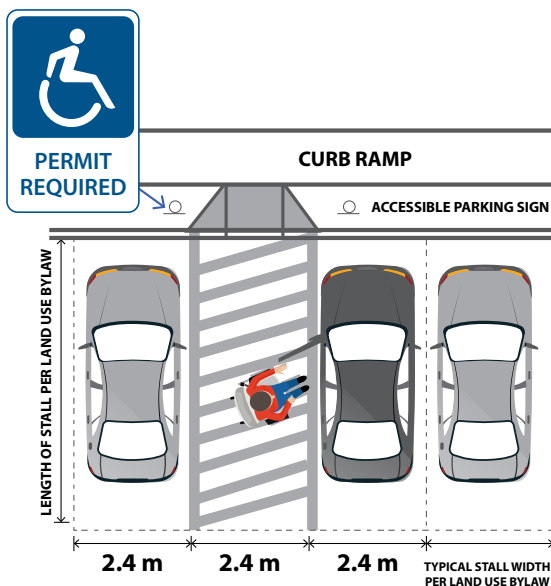
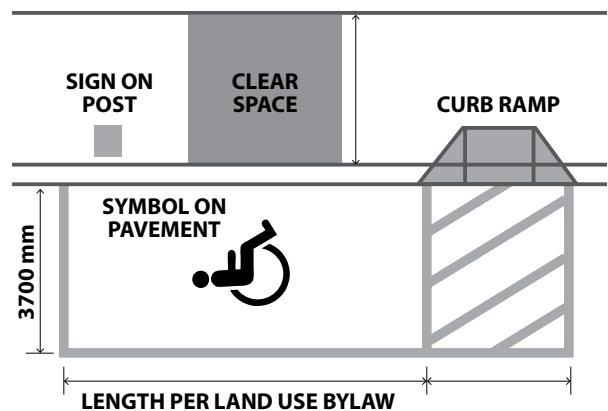

Figure A.6



- The operable parts of ParkPlus machines shall be 900 to 1,100 mm above ground and shall be accessible from a barrier-free path of travel.

Explanation: Universally designed ParkPlus machines ensure everyone can pay for parking easily and conveniently.

- A barrier-free path of travel must be provided from a barrier-free entrance to all levels of a parking structure.
- If oversized vehicles are required to drop off passengers in a parking garage, a minimum 3,100 mm vertical clearance shall be provided.

Explanation: 3,100 mm of vertical clearance ensures that Calgary Transit Access, Calgary Transit and other vehicles that persons with disabilities frequently use shall have access to parkades.

Figure A.9

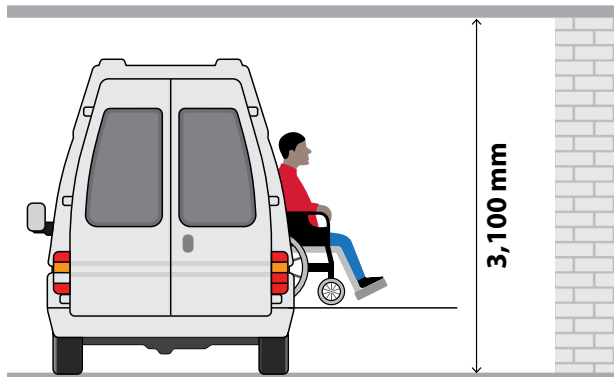

### VERTICAL CLEARANCE

- If “Staff only” and “Visitor only” parking stalls are provided, barrier-free staff parking and/or barrier-free visitor parking stalls must be equally distributed in the development.

Explanation: The allocation of parking to staff and visitors with disabilities ensures equal access to parking stalls. The Alberta Building Code 2014 3.8.2.2.(2) contains the requirements for the number of barrier-free parking stalls that must be provided in a development. The Alberta Building Code 2014 Table 3.8.2.2. shall be used to determine how many barrier-free staff and barrier-free visitor parking stalls are required.

- Street parking stalls for people with disabilities shall be arranged so that people with disabilities do not have to disembark the vehicle in an area that is not protected from vehicular traffic.

Explanation: A parking stall located on the left-hand side of a one-way street (for example) would require someone with a disability to disembark the vehicle in and amongst possible traffic. This represents a hazard. If a barrier of some kind is installed between the parking stall and the street, it may be acceptable.

### Passenger loading zones

- Passenger loading zones shall be provided where it is not feasible to position all of the barrier-free parking stalls within 50 metres of the barrier-free entrances.

Explanation: Loading zones are roadside drop-off areas, separated from the flow of vehicular traffic and usually located in front of buildings along busy streets or roads. Their main function is to allow passengers to get in and out of vehicles safely and conveniently. They are especially beneficial for people with mobility limitations, seniors, persons with strollers or those loading or unloading large or heavy items. Where possible it is recommended that building entrances adjacent to passenger loading zones be covered to provide protection from precipitation and to maintain a slip-free barrier-free path of travel.

- If provided, passenger loading zones shall be located within 50 metres of a building’s main entrance. These loading zones shall have a minimum width of 3,700 mm and a minimum length of 9,000 mm.
- If one or more passenger loading zones are provided, at least one shall be clearly marked for use by people with disabilities.

Explanation: Passenger loading zones provide safe and easy access for persons with disabilities. Please refer to the most recent Barrier-Free Design Guide for diagrams of passenger loading zones. The signage requirements of the Alberta Building Code 2014 3.8.2.2.(4) also apply.

Figure A.14

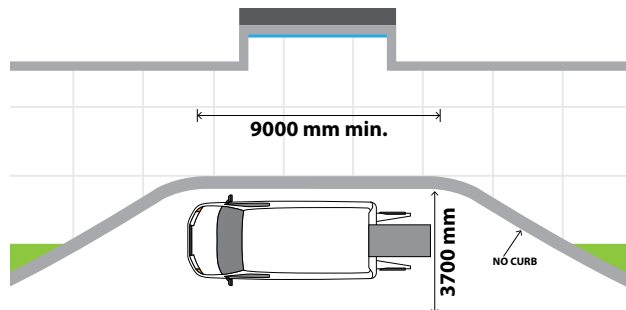



15. Where Calgary Transit Access or Calgary Transit vehicles stop near a building entrance, at least one passenger loading zone shall be designed in accordance with the Alberta Building Code 2014 3.8.2.2.(3), Calgary Transit requirements and these Standards.

Explanation: It is essential that parking areas be accessible to vehicles that people with disabilities may use (e.g. adapted vans, accessible taxis, Calgary Transit Access vehicles, and Calgary Transit vehicles). Loading zones must have barrier-free access to exterior barrier-free paths of travel. The Alberta Building Code 2014 3.8.2.2.(3) discusses the requirements for access aisles, curb ramps and clearance. A curb ramp allows for safe and easy passage to and from barrier-free paths of travel for people with a mobility disability. The curb ramp shall be designed in accordance with Section B 34-41 of these Standards.

## Signage

16. The International Symbol of Access shall be painted on the pavement of all off-street barrier-free parking stalls with non-slip paint and displayed with a vertically mounted sign conforming to the height requirements of Alberta Building Code 2014 3.8.2.2.(4).

Explanation: Proper signage ensures that parking stalls are easily identifiable and accessible to persons with disabilities. It is important that the International Symbol of Access painted on the stall does not occupy the entire area. The more painted surfaces there are, the more likely the parking stall may become slippery.

Figure A.16



17. If the location of designated parking stalls is not obvious or is not visible from a distance, directional signage shall be provided.

Explanation: Directional signage ensures safe and convenient navigation to accessible parking spots. Directional signage that conforms to the Alberta Building Code 2014 Figure A-3.8.3.1.(1) shall be placed along the route to accessible parking stalls.





## B. Exterior paths of travel

All citizens should be able to use exterior paths of travel in The City of Calgary safely, conveniently and independently. This section provides an overview of the Standards for accessibility in exterior barrier-free paths of travel.

The City of Calgary Roads, Transportation Planning and Community Planning must be consulted for all public sidewalks and road concerns.

### Alberta Building Code 2014 references

- 3.8.1.3 Barrier-Free Path of Travel
- 3.8.2.2. Access to Parking Areas and Stall Design
- 3.8.3.1. Accessibility Signs
- A-3.8.3.1. (1) and (2) Accessibility Signs
- 3.8.3.2. Exterior Walks
- 3.8.3.4. Ramps

#### This Section covers:

- Paths of travel
- Obstructions
- Benches
- Curb ramps
- Ramps
- Patios/balconies
- Parks
- Crime Prevention through Environmental Design
- Accessible pedestrian crossings and traffic signals

### Paths of travel

18. Exterior paths of travel shall be a minimum 1,500 mm wide.

Explanation: The Alberta Building Code 2014 3.8.3.2.(1) (b) requires exterior barrier-free paths of travel to be no less than 1,100 mm wide. Access Design Standards require sidewalks to be no less than 1,500 mm wide, as this width allows for two wheelchair users to safely pass each other. The Transportation Association of Canada recommends 1,500 mm – 2,400 mm.

Figure B.18

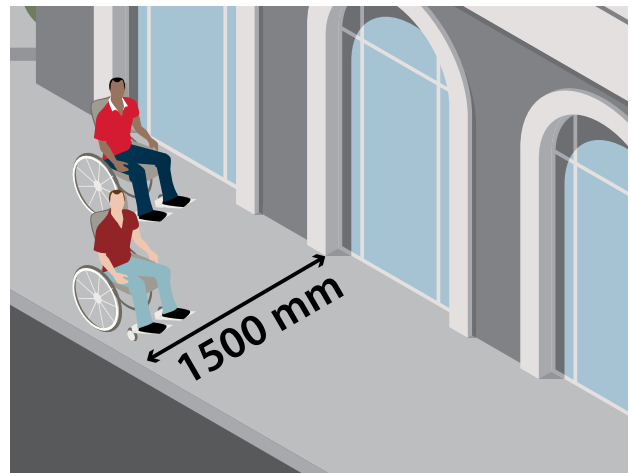

19. Except in back lanes, where an exterior barrier-free path of travel passes behind a loading or garbage pick-up area, audible and visual warning signals shall be installed.

Explanation: Audible and visual warning signals alert people with vision and hearing loss of the hazard of vehicles frequently backing up.

## Obstructions

20. Any lamp posts, tree grates, trees, sign posts, transformers, mailboxes, newspaper stands, trash containers, planters, bus shelters, benches, “sandwich board” signs and other potential obstructions shall be placed outside the minimum required width of the barrier-free pathway (1,500 mm).

Explanation: The placement of the above items can present as a hazard for persons with limited mobility and/or vision loss. Likewise, a planter overhanging guardrails can obstruct paths of travel and should not be used where it could obstruct the barrier-free path of travel.

Figure B.20.a

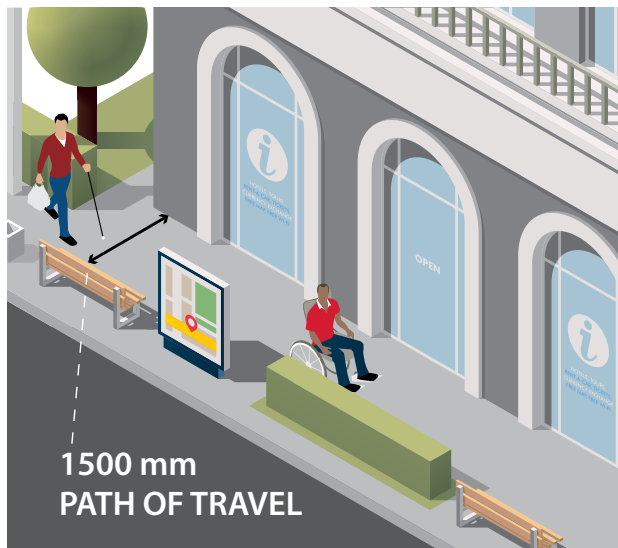

Figure B.20.b



21. In a barrier-free path of travel, objects protruding more than 100 mm from the wall with a top surface higher than 680 mm shall extend to within 200 mm from the floor or ground for the entire length of the obstruction, in order to be cane detectable.

Explanation: In general, nothing is allowed to project more than 100 mm into any barrier free path of travel, whether the path of travel is in a corridor, a room or a washroom. The exception to this is if the obstruction is designed to be cane-detectable. This standard applies to both interior and exterior paths of travel.

Figure B.21.a

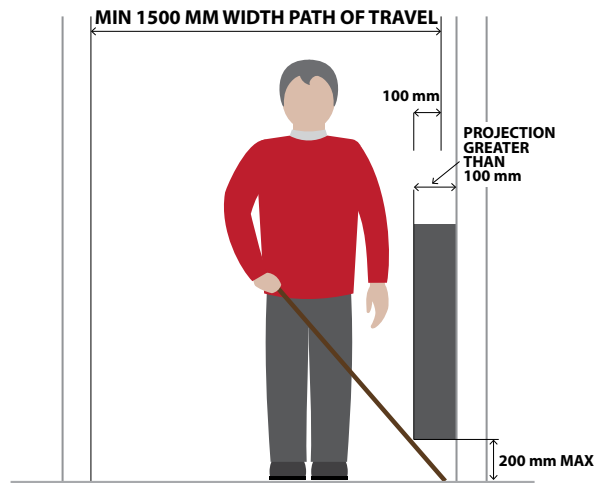

Figure B.21.b



22. Tree branches and any overhead design elements shall not extend below 1,980 mm above the barrier-free path of travel.

Explanation: Projections lower than 1,980 mm above the ground or that project more than 100 mm into an interior barrier free path of travel are permitted as long as they extend perpendicularly down to within 200 mm of the ground. People with vision loss find that obstructions more than 200 mm above the floor or ground level are not cane detectable and therefore represent a hazard.

Figure B.22

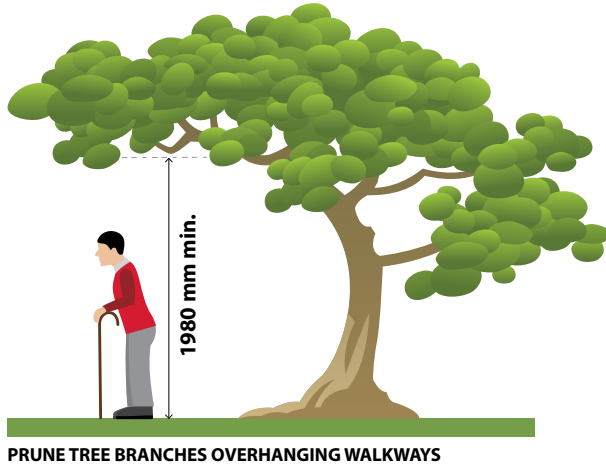

- 23. Guy-wires shall be placed out of the path of travel.
- 24. Manhole covers, tree grates, electrical vaults and other access covers/grates shall be placed adjacent to walkways, outside of the path of travel (unless prevented by site constraints). The gratings shall have a maximum clear opening of 13 mm.

Explanation: The long dimension of the openings shall lie perpendicular to the path of travel, and if small solid plates (like footprints) are placed in the direction of pedestrian traffic and spaced to accommodate an average stride, a person wearing high heels can cross gratings safely. Some grating on electrical vaults may be larger (openings no larger than 20 mm wide x 90 mm long to meet transformer ventilation requirements, as specified by ENMAX.).

Figure B.24.a

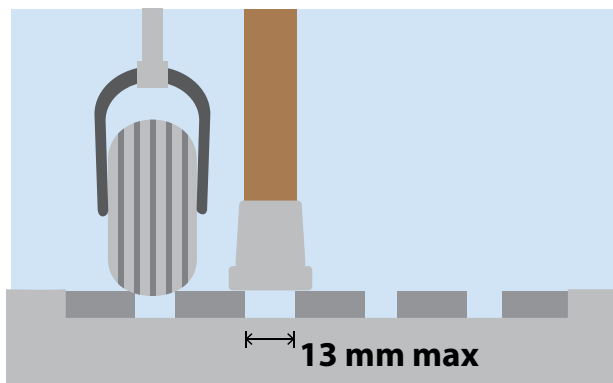
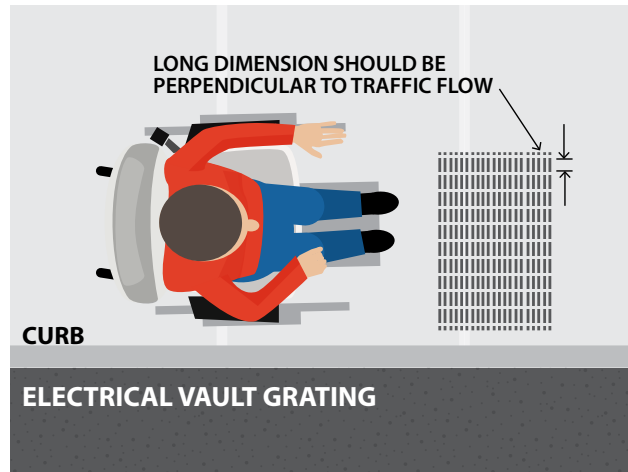

Figure B.24.b



- 25. The minimum height of bollards and posts shall be 600 mm. They shall colour contrast from the surrounding pavement.

Explanation: Colour contrast improves visibility and the height requirement ensures the bollard or post is not a hazard for people with vision loss. Please refer to CoLATE principles as reviewed in the glossary or visit the CNIB website for additional direction on colour selection.

*Note: Where the entrance to a pathway is on a street, refer to The City of Calgary Parks Detail sheets # 31 and 32 for providing bollards.*

- 26. Chains, cables or ropes shall not be installed in barrier-free paths of travel.

Explanation: This is to ensure chains, cables or ropes do not present a hazard or barrier for people with disabilities.

## Benches

27. If installed, benches with arm rests, backrests and adequate heel space below the bench shall be placed adjacent to a barrier-free path of travel.

*Note: Adequate heel space can help make rising from a seated position easier.*

28. The seat height shall be not less than 450 mm and not more than 500 mm from the ground.

**Figure B.28**

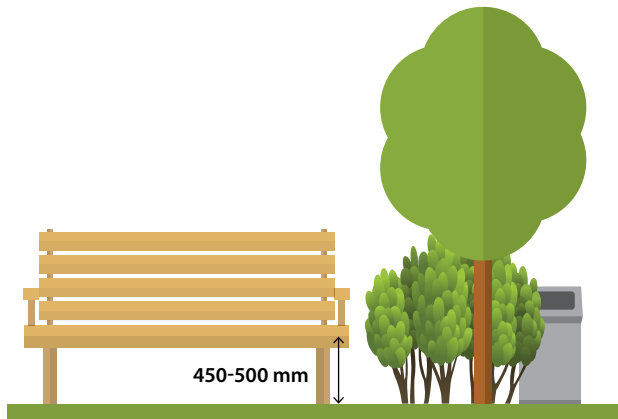

### READILY AVAILABLE BENCHES ARE IMPORTANT TO THOSE WHO TIRE EASILY

29. Armrests shall be mounted 200 mm above the height of the seat pan.
30. To accommodate a wheelchair, there shall be a level and firm ground surface at least 850 mm x 1,200 mm adjacent to the bench.
31. Seat surfaces shall be pitched to shed water, but not drain out onto walking surfaces where surface water or ice may create a hazard.
32. Seat surfaces and vertical supports shall be designed to avoid accumulating snow and debris.
33. Benches shall colour contrast from the surrounding area.

**Figure B.33**

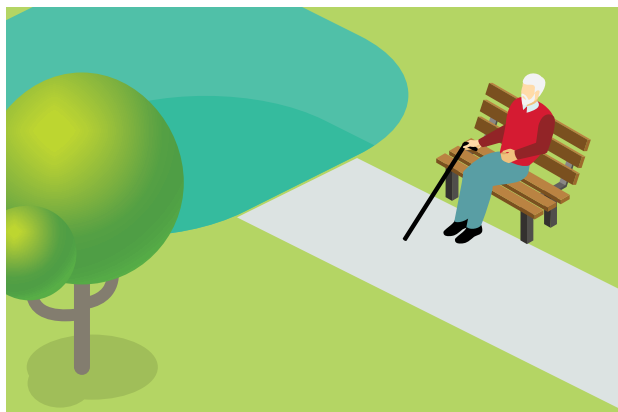

## Curb ramps

34. Curb ramps shall be constructed in accordance with The City of Calgary Roads' most recent Standard Specifications Road Construction.

35. Curb ramps are required to be installed wherever an exterior barrier free path of travel encounters a curb, such as at a roadway, as per the Standard Specifications Roads Construction.
36. Curb ramps should be located so that they are aligned perpendicular to the intended path of travel.  
 Explanation: At times, curb radii and traffic safety concerns preclude the alignment of the curb ramp perpendicular to traffic. In such cases, the curb ramps shall discharge into the painted crosswalk, as close as possible to a perpendicular alignment with traffic flow.

Figure B.36



37. A 1,500 mm x 1,500 mm level surface shall be maintained on the sidewalk behind the curb ramps.  
 Explanation: 1,500 mm x 1,500 mm allows adequate space for a wheelchair user to wait for foot traffic to clear, if needed, before negotiating the ramp. Where curb ramps line up with a pathway route crossing the street, curb ramps should be lined up for visual continuity.

**Note:** Where the entrance is on a street and there is no existing concrete sidewalk, refer to The City of Calgary Parks Detail Sheet #34 for provisions for an asphalt wheelchair ramp complete with depressed concrete curb.

Figure B.37

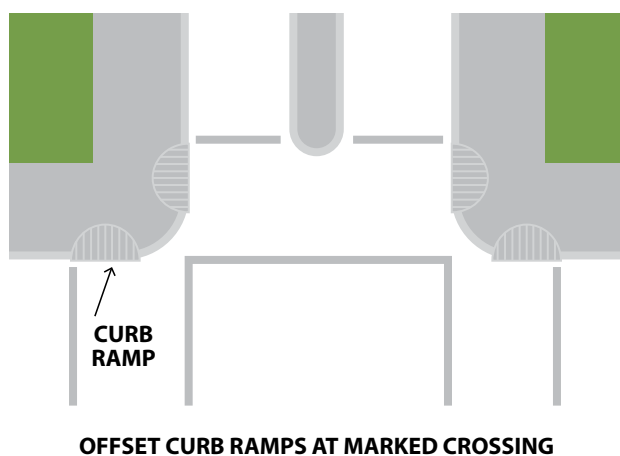

38. Curb ramps shall contrast in texture from the surrounding sidewalk and the road.  
 Explanation: Contrast in texture allows the curb ramp to be detected by cane and thereby enhances the safety of pedestrians with vision loss.
39. Drainage shall be designed to prevent water and snow accumulation at the bottom of curb ramps. However, catch basins should not be located in front of curb ramps.
40. Catch basins shall not be located at entrances to Regional pathways.
41. Raised pedestrian crossings shall be designed one of two ways. They can be designed so that the raised pedestrian crossing is at an elevation that is halfway between that of the sidewalk and the road, and with curb ramps at each end. Or they can be designed so that the raised pedestrian crossing is at an elevation equal to the sidewalk with tactile treatments (such as truncated domes) at each end of the walkway.

Explanation: Raised pedestrian crossings are often found in front of entrances to recreation centres. They are advantageous because they allow people in wheelchairs or those with hockey bags or strollers to cross a road without having to negotiate a change in elevation. However, they can be hazardous to people with vision loss because the location of the road with respect to the sidewalk can be difficult to detect with a cane. The first option above provides some semblance of a curb ramp that can be detected by people with vision loss. Although a change in elevation must be negotiated by people in wheelchairs, it is a lesser grade change than would normally be expected for a curb ramp. The second option maintains the ease of use for people in wheelchairs, but provides a tactile warning for people with vision loss that can be detected by a cane prior to crossing the road.

Figure B.41.a

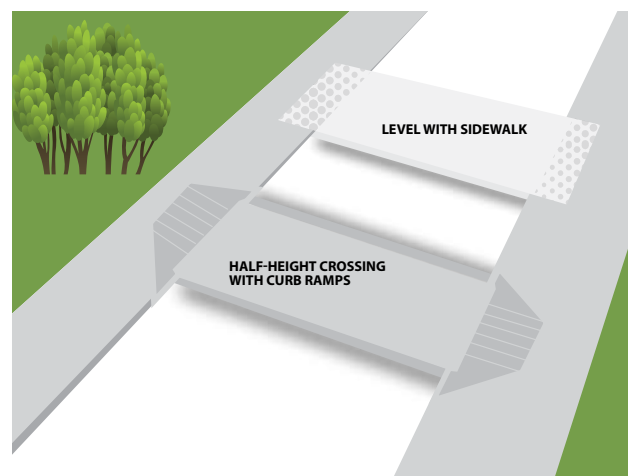
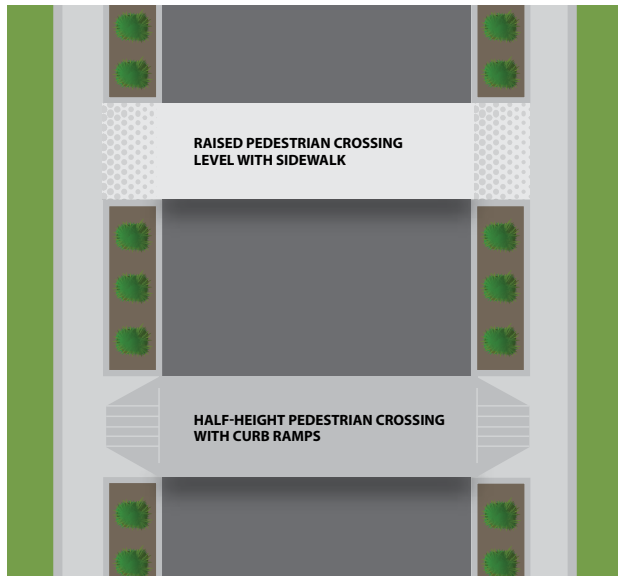

Figure B.41.b



## Ramps

Exterior ramps and stairs shall be protected from rain, snow and ice, or maintained free of snow and ice through regular maintenance or appropriate heating and drainage systems installed beneath the ramp or stair surface.

- 42. Non-glare materials shall be used on the ramp surface.
- 43. Where a ramp serves more than 100 occupants, ramps shall be 1,600 mm wide between handrails.

Explanation: Taking into account the minimum dimension for a handrail and its clearance from the wall it is installed on, the total inside width of the ramp will be at least 1,800 mm. When a ramp serves more than 100 occupants, it is likely that two or more occupants will be people who use a wheelchair. It is therefore necessary that the ramp be designed to allow two wheelchair users to pass one another on a ramp.

- 44. If a ramp makes a 90 degree turn, the landing shall be 1,500 mm long x 1,500 mm wide.

Explanation: The Alberta Building Code 2014 3.8.3.4(1)(f) requires a landing in a ramp to be 1,200 mm long where it makes a 90-degree turn. In City of Calgary buildings, the 1,500 mm is applied to accommodate the length of a wheelchair as it negotiates a corner.

- 45. Ramp slopes are required to be a maximum 1:20 (5 per cent).\*

*\*Exception - where the ramp is 3 metres or less in length, it is permitted to have a slope of 1:12.*

Explanation: Ramps with a slope of 1:20 or steeper shall be designed in accordance with the Alberta Building Code 2014 and these Standards. The Alberta Building Code 2014 3.8.3.4(3) only requires ramps with a slope between 1:12 and 1:20 to be designed as ramps. In City of Calgary buildings, ramps with a slope between 1:20 and 1:25 are required to be designed as ramps.

- 46. An elevator or lift shall be provided if there is a change in elevation of more than 1.2 metres and the elevation change is within a building.,

Explanation: A ramp with a 1:20 slope negotiating an elevation change of 1.2 metres will be 24 metres long, plus the length of any landings. At this size, the length of the ramp can become just as much of an obstacle as the slope of the ramp. Though an elevator or lift is required only for interior scenarios, it is advised to provide the same amenity for exterior ramps..

- 47. The maximum cross slope of ramp surfaces shall be 1:50 (2 per cent).

- 48. All ramps shall have a landing in conformance with the Alberta Building Code 2014 3.8.3.4.(1)(d).

Explanation: The Alberta Building Code 2014 3.8.3.4(1)(d) requires a level area occurring at set maximum intervals. The level areas can serve as a rest area for someone using a long ramp.

Figure B.48

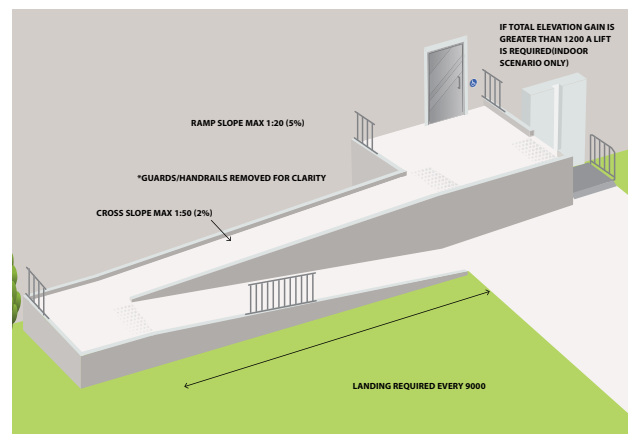

## Patios/balconies

49. Exterior patios and balconies shall be accessible from adjacent interior and exterior barrier-free paths of travel.

50. A minimum clear turning radius of 1,500 mm shall be provided on a balcony/patio.

Explanation: A 1,500 mm radius ensures a wheelchair user has the ability to change directions.

51. If provided on a patio or balcony, planter boxes and other obstructions must not project into the barrier-free path of travel.

Figure B.51

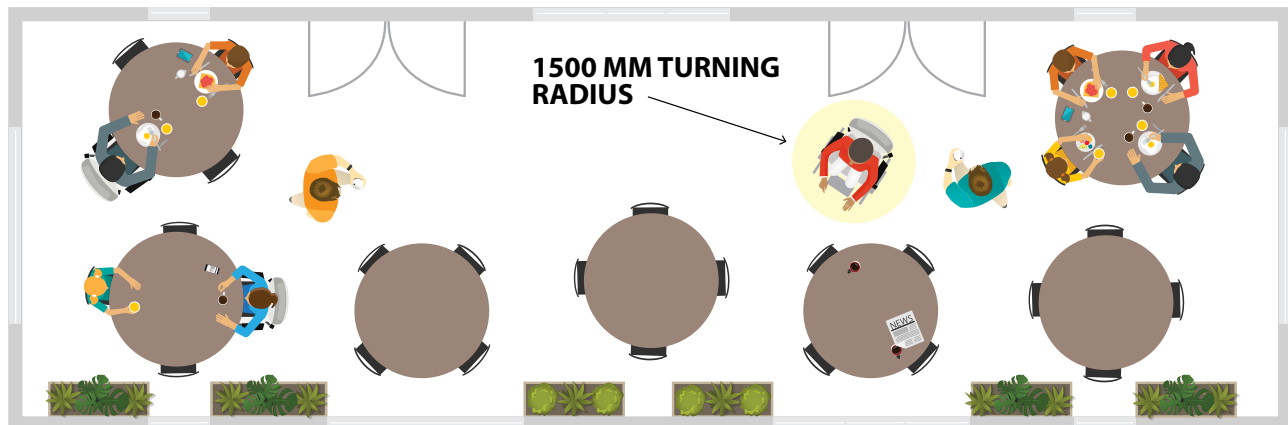

### PLANTER BOXES NOT IMPINGING ON PATH OF TRAVEL

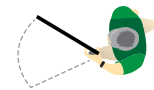

*Note: See Standard 21 for detailed requirements for how to treat projections into a barrier-free path of travel.*





## Parks

In addition to the Standards below, all applicable Section B Standards shall be applied to all City of Calgary parks.

- 52. All parks shall be accessible from adjacent communities and provide a barrier-free path of travel.
- 53. All pathways shall be designed to drain water appropriately, in order to avoid puddles and ice build-up.
- 54. Park signage of points of interest, warnings and other important information shall include raised characters that colour contrast from the sign's background.
- 55. Horizontally oriented sign surfaces containing points of interest, warnings and other important information shall be 860 mm above the ground and tilted.

Explanation: Horizontally oriented signs are often used in park settings for interpretive purposes. It is important that they are positioned such that people in wheelchairs can see the information. It is also important to ensure there is adequate lighting to highlight signage when daylight is not available. It should be noted that City of Calgary Parks currently uses the corporate branding policy for all signs and the signage is designed with the Creative Services team.

Figure B.55



- 56. Where accessible picnic tables are provided, they are to be located adjacent to an accessible path of travel on a level, firm surface with a knee space at least 750 mm wide, 500 mm deep and 760 mm high.

*Note: It is recommended that 20 per cent of picnic tables provided be accessible.*

Figure B.56

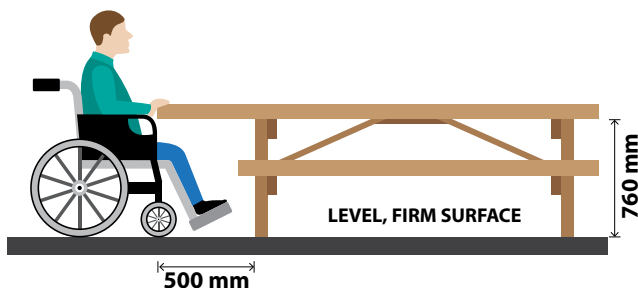

PICNIC TABLES

- 57. Fences, earth berms or other similar structures shall be no higher than 1,000 mm above the ground.
- 58. Posts, bollards, maze gates or other devices designed to prevent or restrict vehicular, pedestrian, or cyclist access shall have a minimum clearance of 1,200 mm from adjacent obstructions.

Figure B.58.a



Figure B.58.b

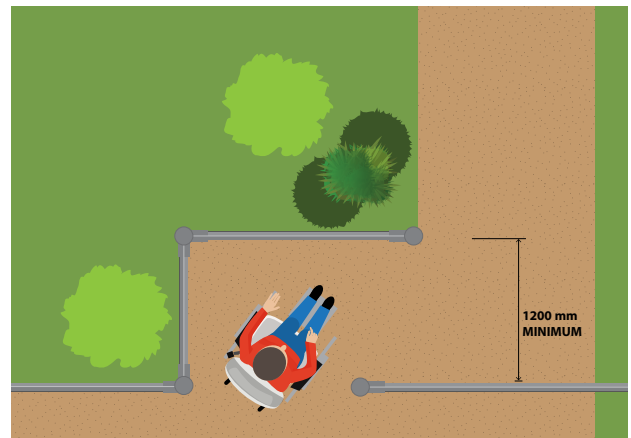

MAZE GATE WITH BARRIER-FREE PATH OF TRAVEL

Explanation: A 1,200 mm clearance allows access for wheelchair users and adapted or tandem bicycles used by people with physical disabilities and/or vision loss.

## Crime Prevention through Environmental Design (CPTED)

Consideration of crime prevention through effective design and conscious use of the physical environment can help reduce the incidence of criminal behaviour, thereby improving the quality of life for all Calgarians. Although crime prevention through design can benefit everyone, it can have particular benefit for people with disabilities as they can be more vulnerable in some situations.

### References

Development Permit applications, including multi-residential, industrial, commercial and public developments may request a CPTED review. For more information or a CPTED review of designs, please contact:

**Calgary Police Services - Crime Prevention Unit**  
**5111 – 47 St. N.E.**  
**Calgary, AB T3J 3R2**  
**Telephone: 403-509-1754**  
**Fax: 403-509-1757**

Explanation: Security guards or police provide surveillance and access control, but are labour intensive and expensive. Capital or hardware intensive security (e.g., alarms or cameras) also provide access control and surveillance. Territory is defined by sidewalks, landscaping, porches and other elements that establish the boundaries between public and private areas. Access control uses pathways, corridors, sidewalks, doors, shrubs, fences, gates and other physical design elements to discourage access to an area by all but its intended users. Signage is also used for establishing rules and for advertising the consequences of non-compliance (e.g. allowed or disallowed activities, parking, age restrictions (commonly used for playgrounds, parks and activities), and hours of operation).

The location of windows allows a person to be aware of exterior activities. Surveillance is achieved by placing windows in locations that allow intended users to see or be seen while ensuring that intruders will be observed as well. Surveillance is enhanced by providing adequate lighting and landscaping that allows for unobstructed views.

The general design strategies listed above can be applied in any environment to improve natural access control, natural surveillance and territorial behaviour to:

- Provide a clear border definition of controlled space.
- Provide a clearly marked transition from public to semi-public to private space.
- Locate gathering areas in places with natural surveillance and access control, and away from the view of potential offenders.
- Provide natural barriers to conflicting activities.
- Improve the scheduling of space to provide for effective and critical intensity of uses.
- Design space to increase the perception of natural surveillance.
- Overcome distance and isolation through improved communications and design efficiencies (e.g. emergency telephones, pedestrian paths).

## Accessible pedestrian signals at signalized crossings

Accessible pedestrian signals assist people with disabilities to safely cross a signalized intersection. Well-designed signalized intersections direct pedestrians safely across a road, preventing them from walking into traffic. The accessible pedestrian signal acts as confirmation of the traffic flow and as a directional indicator for people with vision loss. It also serves as a pacer to people with cognitive disabilities. This section outlines The City of Calgary's standards for accessible pedestrian crossings.

The City of Calgary Roads and Transportation Planning must be consulted on all matters concerning pedestrian crossings and traffic signals on public sidewalks and roads. Accessible pedestrian signals are considered for installation as per citizen requests.

Please contact the Advisory Committee on Accessibility for regulations governing accessible pedestrian traffic signals:

**Advisory Committee on Accessibility**  
**Telephone: 3-1-1**  
**TTY: 403-268-1379**  
**Email: [ACA@calgary.ca](mailto:ACA@calgary.ca)**

## Pedestrian push buttons

59. Push buttons shall have the ability to be activated using any part of the arm or hand.
60. All traffic signals shall be set to allow sufficient time for pedestrians to complete the crossing safely.

## Accessible pedestrian signals

61. Push buttons shall be located on the side of the pole parallel to the sidewalk and ideally at a height of 1,000 mm – 1,100 mm above the ground, as site conditions permit.
62. Push buttons that activate visual pedestrian signals shall also operate the audible pedestrian indicators.
63. Tactile direction arrows shall be provided near push buttons and located in a standardized location at the crosswalks, so that people with vision loss can readily find them.
64. Audible pedestrian signals shall be located at all new signalized intersections that accommodate pedestrians. These audible signals shall be set to allow sufficient time for pedestrians to cross safely.  
Explanation: In the general case, signals within the City of Calgary accommodate the crossing of pedestrians. There are, however, some scenarios where no pedestrian facilities exist on the approach to the signal. These signals have no pedestrian heads, no pushbuttons and do not accommodate any pedestrians.

65. The sound cue shall be clearly audible above the ambient noise of the signalized intersection area.

Explanation: Under normal conditions, the tones used shall be a chirp sound for crossing east/west and a cuckoo sound for crossing north/south. For the sake of safety, the two tones shall be consistent throughout the City.

66. One audible sound unit shall be installed at each end of a crosswalk.
67. When the unit is operated, a tone shall sound for the full duration of the walk interval.
68. Audible signal posts shall constantly emit a slow, intermittent temporal pattern of sound, which is distinguishable from the crossing signals. This sound will indicate the presence of the crosswalk and the location of the push-button to a person with vision loss, and will serve as an audible beacon on the opposite side of the road.

Figure B.68





## C. Building entrances

Entrances, especially main accessible entrances must be easily identifiable in the facade. Seasonal weather conditions, such as strong winds and drifting snow, should be mitigated in the design of building entrances, to ensure normal operation of doors in inclement weather. This section covers The City of Calgary's Standards for accessible entrances.

### Alberta Building Code 2014 references

- 3.8.1.2. Entrances
- 3.8.3.1. Accessibility Signs
- 3.8.3.3. Doorways and Doors
- A-3.8.3.3. Doorways and Doors

#### This Section covers:

- Entrances
- Service dog relieving areas
- Plus-15 Skywalks

### Entrances

69. Every entrance intended to be used by the public or by employees who could reasonably be expected to have disabilities shall be barrier free.

**Note:** *Except service entrances and residential occupancies, where other requirements apply.*

Explanation: The Alberta Building Code 2014 3.8.1.2.(2) requires "at least one" barrier-free entrance to a suite that is completely separated from the rest of the building.

The Alberta Building Code 2014 3.8.1.2.(2) only applies to assembly, business and personal services and mercantile occupancies. For City of Calgary buildings, all entrances to such suites shall be barrier free.

Figure C.69

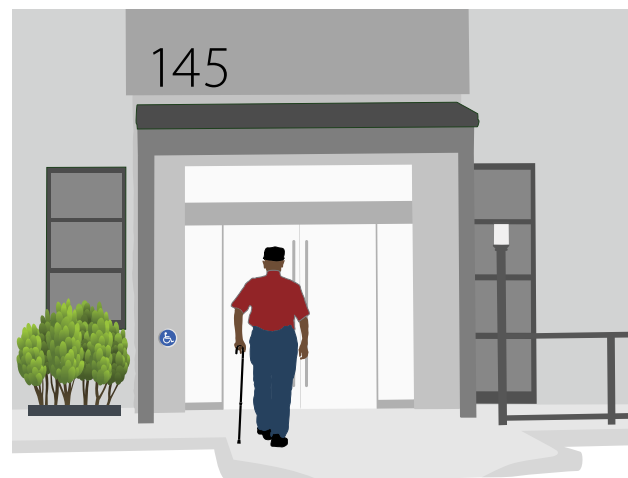

70. Drainage shall be directed away from the entrance.

71. All barrier-free entrances shall be provided with power door operators.

**Note:** Except a building of residential occupancy where none of the dwelling units are accessible from an interior corridor.

Explanation: The Alberta Building Code 2014 3.8.3.3.(5) and (6) only require certain types and sizes of buildings to have power door operators at the barrier-free entrances. However, all City of Calgary buildings are required to have power door operators for all types and sizes of buildings at barrier-free entrances.

Figure C.71



72. If an entrance has a power door operator, and there is a vestibule immediately inside the doors, the vestibule doors shall also be equipped with a power door operator.

73. Power door operators shall be installed at 800 mm +/- 50 mm, above finished floor, measured to the centerline of the device.

74. If an entrance has a power door operator, the location of the actuating devices for the power door operators shall conform to the Alberta Building Code 2014 A-3.8.3.3.(5)

Explanation: The Alberta Building Code 2014 A-3.8.3.3.(5) addresses the installation location for power door operators. Actuating devices for power door operators (i.e. push-buttons) shall be located such that a wheelchair will not interfere with the operation of the door once it is actuated.

75. All doors in a barrier-free path of travel shall have a clearance beyond the latch side of the door conforming to the Alberta Building Code 2014 3.8.3.3.(10).

Explanation: The Alberta Building Code 2014 3.8.3.3.(10) requires certain clear space beyond the latch side of a door, but only where the door is within a suite. In City of Calgary projects these clearance requirements apply to all doors in a barrier-free path of travel, whether the door is in a suite or not.

Figure C.75

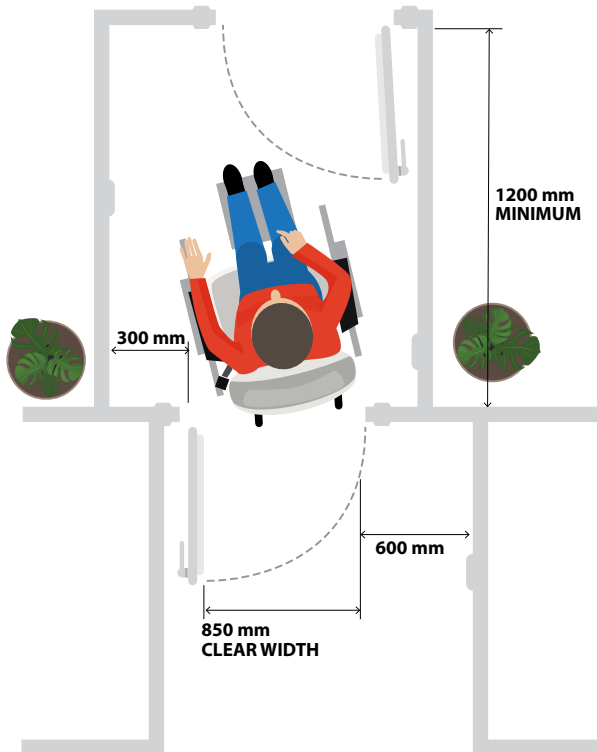

76. Door release hardware shall be installed not less than 800 mm and not more than 1,100 mm above the finished floor.

Explanation: To ensure a wheelchair user is able to reach door release hardware.

77. In any set of two or more doors or gates, the door opening shall alternate between right- and left-hand operation.

Figure C.77



Explanation: If an entrance has three doors, there shall be one set of double doors and the third door can be hinged on either the left- or right-hand side. As another example, if there are two doors in a series, the inner door and outer door should be hinged on opposite sides.

This design enables people to operate the door with one hand on the side of their choice and avoid the need to reach across or travel backwards through the door. People with an occupied hand, including those with a support cane, white cane or guide dog, would be able to use their free hand to open the door without having to reach across.

**Note: Any exemptions to this Standard must be reviewed by the Advisory Committee on Accessibility.**

78. When turnstiles or revolving doors are provided, a swing door with an automatic door control shall be placed immediately to one side of the revolving door or turnstile.

## Service dog relieving areas

79. A service dog relieving area shall be provided within 50 metres from at least one barrier-free entrance.
80. The dedicated relieving area shall be approximately 7.4 metres square (3 metres in diameter circle).

Figure C.80

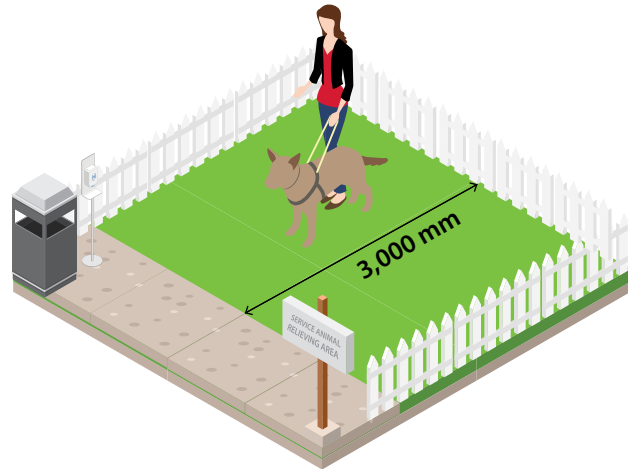

Explanation: Service dogs accompanying their owners on trips will reasonably require a relieving area at entrances and bus/train terminals where passengers are provided the opportunity to disembark.

A 7.4 metre square area allows a service dog on a 5-foot leash to circle its handler prior to relieving itself. Organic mulch or grass works well in a relieving area, but service dogs are also trained to relieve themselves on hard surfaces like concrete. Other considerations for relieving areas include locating the area away from high-traffic areas, providing a garbage can for hygienic disposal of waste, and providing a water source to facilitate the cleaning of the area by building staff. Operators may also consider providing plastic bags for cleanup. Tactile signage should be provided which explains what the area is and also reminds users to clean up after their dogs. Requirements for tactile signage stated in this document shall be followed.

81. The service dog relieving area shall be connected to a barrier-free path of travel.

## Plus-15 Skywalks

An accessible Plus-15 Skywalk system ensures people with disabilities can travel through the downtown core easily and safely without having to contend with hazards like vehicular traffic and sidewalk obstructions at grade level.

Figure C.82.a

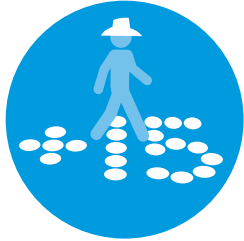

### References

Land Use Bylaw 1P2007

Plus-15 Policy

Alberta Building Code applications to Plus-15 systems

Standard Development Agreement

Report on City of Calgary Plus-15 Access Stairs

The City of Calgary Regulation Bulletins (produced by the Building Regulations Division)

## Standards

82. The minimum unobstructed width for Plus-15 Skywalks, bridges and lane links shall be 4,500 mm.

Figure C.82

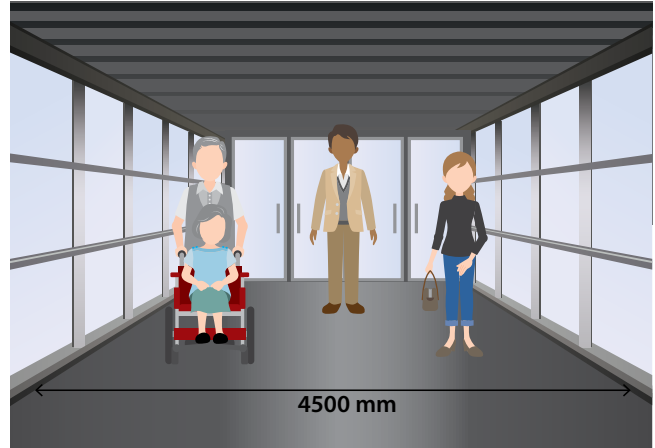

### PLUS-15 SKYWALK

83. The minimum unobstructed width for Plus-15 Skywalk stairs shall be 2,000 mm.

84. An elevator shall be installed to provide access to both grade and Plus-15 Skywalk levels.

85. Automatic sliding doors or automatic swinging doors shall be installed at the entrances to a Plus-15 Skywalk.





## D. Interior paths of travel

In addition to vehicular access, exterior paths of travel and entrances, it is important that interior paths of travel are accessible for people with disabilities. This section outlines The City of Calgary's Standards for accessibility in interior paths of travel.

### Alberta Building Code 2014 references

- 3.3.1.7. Protection on Floor Areas with a Barrier-Free Path of Travel
- 3.5.2.1. Elevators, Escalators and Dumbwaiters
- 3.8.1.2. Entrances
- 3.8.1.3. Barrier-Free Path of Travel
- 3.8.1.4. Access to Storeys Served by Escalators and Moving Walks
- 3.8.1.5. Controls
- 3.8.3.5. Passenger-elevating devices
- 3.8.2.1. Areas Requiring a Barrier-Free Path of Travel
  - A-3.8.2.1. Access to Rooms and Facilities
  - 3.8.3.1. Accessibility Signs
  - 3.8.3.3. Doorways and Doors
    - A-3.8.3.3.(3) Lever Handles
    - 3.8.3.4. Ramps
    - 3.3.1.13. (5) Doors and Door Hardware

#### This Section covers:

- Paths of travel
- Doors and doorways
- Stairs
- Handrails
- Ramps
- Elevators
- Areas of refuge

### Paths of travel

- 86. Where a barrier-free path of travel turns a corner, the corner shall be designed to allow a person using a wheelchair to turn in an open space that has a diameter of not less than 1,500 mm.

Figure D.86

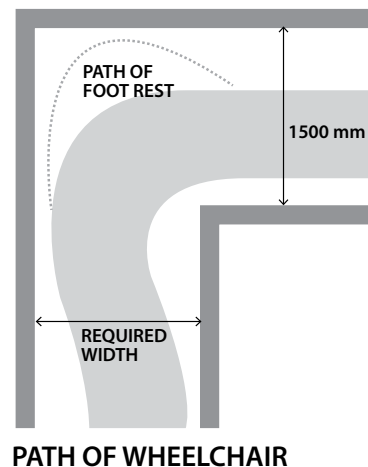

- 87. A barrier-free path of travel shall be 1,500 mm wide in a public corridor or a corridor used by the public that serves floor areas with an occupant load of more than 200, and in suites or rooms with an occupant load of more than 200.

Figure D.87

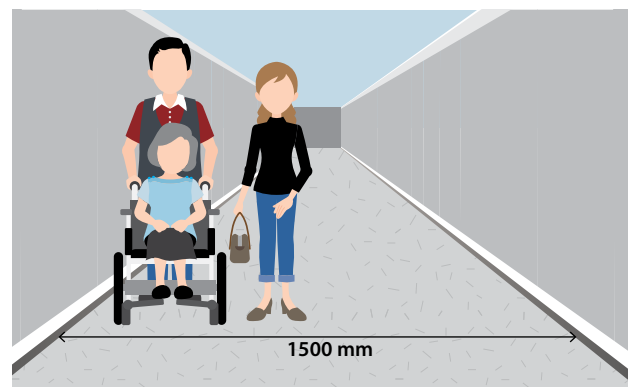



- 88. All interior obstructions in a barrier-free path of travel shall be designed in accordance with Section B 21 of these Standards.
- 89. Carpet on floor, stairs or ramp surfaces shall be securely attached.

Explanation: Surface materials along circulation routes should not impede pedestrian movement, particularly for wheelchair users or people with vision loss. Carpets with a tight weave, low pile and firm underlay are recommended.

Figure D.89

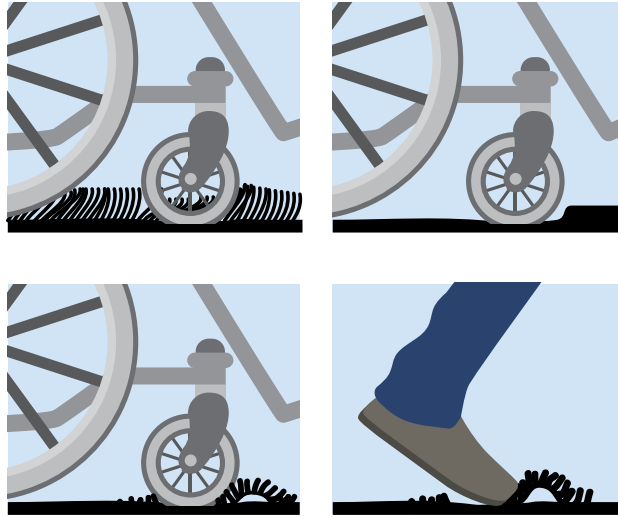

- 90. All floor surfaces shall be slip resistant, non-glossy and stable. The co-efficient of friction shall be no less than 0.5 when wet or dry.

Explanation: Slip-resistant, non-glossy and stable surfaces make for an easier pathway for all users, in particular for people with vision loss who may be negatively impacted by high-gloss and unstable surfaces.

Figure D.90

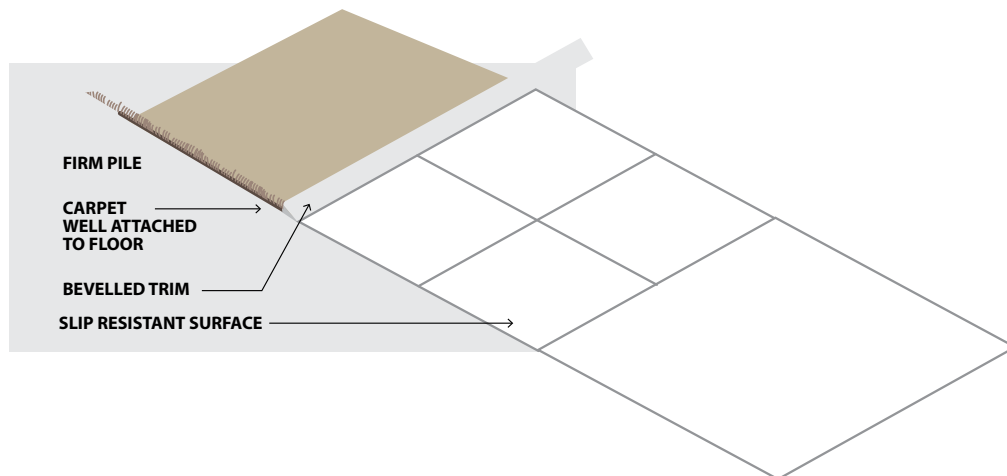

- 91. All surfaces shall be designed so they do not create glare. Pattern design shall also be kept to a minimum.

Explanation: Surface glare and busy patterns can distort perception and generate confusion. It is essential that surfaces do not distort perception or create glare.

- 92. Where wall surfaces are constructed entirely of mirror or glass, there shall be a horizontal warning strip, such as an adhesive film or graphic a minimum of 150 mm wide and 1,350 mm above floor level.

Explanation: A horizontal warning strip on a mirror or glass wall creates contrast, warning users that the surface is mirror or glass. This contrasting strip helps prevent collision with the wall surface.

- 93. All storeys and mezzanines must be reachable by a barrier-free path of travel.\* This means they must be served by an elevator or other elevating device.

\*Exception – residential suites, where other requirements apply.

Explanation: The Alberta Building Code 2014 provides definitions for storey and mezzanine. There may be situations where it is permissible not to provide a barrier-free path of travel to an upper or lower storey. One example is the upper floor of a fire hall, where the upper floor spaces are for firefighters only. Since active firefighters generally do not have physical disabilities, it is considered unnecessary to provide a barrier-free path of travel to those areas. However, if the public will be invited into these areas from time to time (e.g. school tours, Doors Open YYC, etc.), a barrier-free path of travel should be provided.

## Doors and doorways

94. Where a door swings into a barrier-free path of travel, it shall be recessed so that it does not reduce the minimum required width of the barrier-free path of travel.

Explanation: Due to Building Code regulations, exit doors must open outward, which can create a hazard for people with vision loss, especially automatic swing doors. Alternatively, the barrier-free path of travel may be made wider to accommodate the width of the door that swings into the path.

Figure D.94

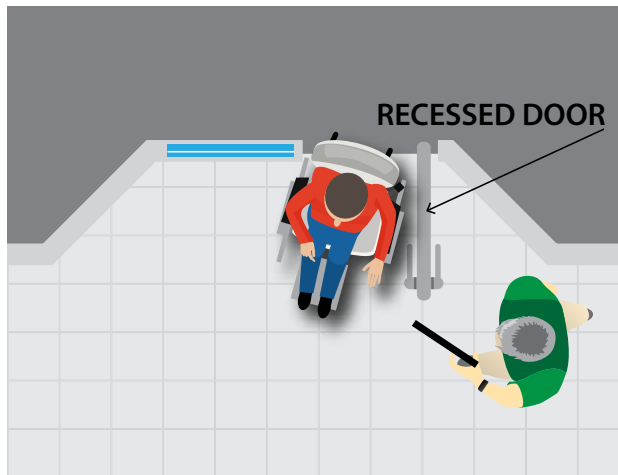

95. Where provided, manual door openers shall be mounted at a height of 800 mm to 1,100 mm from the floor.

Explanation: Although the Alberta Building Code 2014 3.3.1.13.(5) requires door release hardware be mounted not more than 1,200 mm above the floor, in City of Calgary buildings, a higher degree of accessibility is required.

96. Clearance between the door handle and a door shall be a minimum of 50 mm.

Explanation: A clearance of 50 mm ensures that those with limited hand functions can open the door with only one arm.

97. Automatic doors shall have a master control that can control the door closers, keeping the door open for a minimum of eight seconds, with the door held at an angle between 70 – 90 degrees.

Explanation: Master controls also allow the door function to reverse if an object interrupts the door's closing motion.

Figure D.97



## Stairs

98. A flight of stairs shall have uniform dimensions and no open risers.

Explanation: Light can shine through open risers from behind, causing glare. As well, an open riser can be more difficult to detect with a cane, making open-riser stairs difficult for people with vision loss to negotiate.

Figure D.98



99. Nosings shall contrast in colour from stairs.

Explanation: The Alberta Building Code allows either a colour contrast or a distinctive pattern on stair nosings, however, colour contrast is required in City of Calgary buildings to ensure stair nosings are visible to people with vision loss.

**Note:** Please refer to the Appendix for guidance on effectively using colour and contrast in designing interiors for accessibility.

100. Nosings shall not have projecting undersides and shall be bevelled not more than 60 degrees with respect to the tread surface.

Explanation: This is to ensure the tread edge is more clearly visible in descent.

101. Minimal pattern shall be used on carpet and/or tiles on stairs.

Explanation: Heavily patterned carpets and other flooring surfaces can create figure-ground confusion and hide the definition of nosings.

102. Illumination shall be positioned to minimize glare and shadow.

Explanation: This allows the stairway to be accessible to people with vision loss. Please refer to Appendix A for guidance on effectively using lighting when designing for accessibility.

103. A cane-detectable barrier shall be used to prevent access to areas under a cantilevered staircase.

Explanation: A barrier prevents a visually impaired person from inadvertently colliding with the underside of a cantilevered staircase. The barrier should also be cane detectable to alert a blind person to this hazard.

Figure D.103

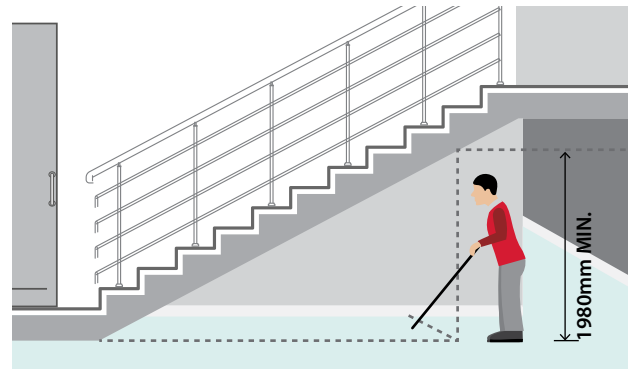

### A CANE DETECTABLE BARRIER IS REQUIRED UNDER THE STAIRS

104. A change in downward elevation shall be indicated by a tactile warning surface comprised of truncated domes as per Canadian Standards Association B651 and with dimensions conforming to the Alberta Building Code 2014 3.3.1.7.(6).

Explanation: The tactile warning surface is to be located at stairs, unprotected drop-off edges greater than 250 mm, edges of reflecting pools, and entries to a vehicular route where no other curbs or elements separate the vehicular route from a pedestrian route. The tactile surface serves to warn a person who is vision impaired that there is a downward change and possible tripping or fall hazard with the walking surface.

**Note:** Calgary Transit applies the domed tactile walking surface at the edge of platforms but may elect to use differing types of tactile warning surfaces at stairs and ramps. Calgary Roads is currently conducting a pilot project with tactile warning surfaces on sidewalks where a hazard may be present.

Figure D.104

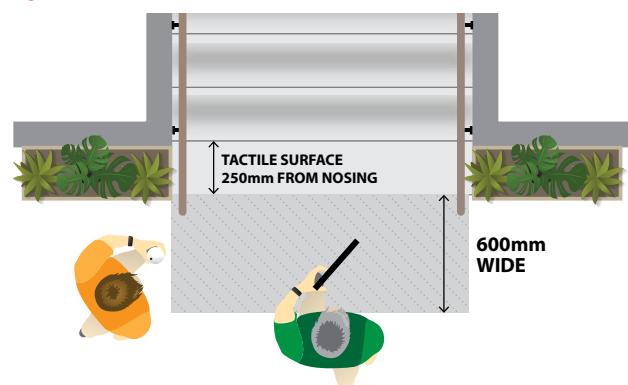

## Handrails

105. Handrails shall be located on both sides of stairs and ramps and shall contrast in colour and brightness to the wall or surrounding area.

Explanation: Handrails on both sides of a stairway or ramp allow for safe and accessible travel in both directions. Colour contrast makes the handrail easier to see and navigate for all users, especially people with vision loss.

106. In all stairs and ramps where people with disabilities are expected to be present, all handrails shall have a consistent system of tactile cues, such as notches, dimples, grade 1 braille, raised numbers or other texture changes within the last 300 mm at both ends of the handrail..

Explanation: This indicates to people with vision loss that they are approaching the beginning or end of the stairway or ramp.

## Ramps

See Section B 42 – 48 and Section D 86 – 93 of these Standards.

## Elevators

107. Elevators shall be built in accordance with American Society of Mechanical Engineers A17.1-2010 / Canadian Standards Association B44 (ASME A17.1-2010/CSA B44-10) Appendix E.

Explanation: ASME A17.1-2010/CSA B44-10 Appendix E outline the requirements for accessible elevators, including door timing and car calls, dimensions of elevator cars, buttons, keypads, visible and audible indicators and emergency communications.

108. The minimum space in front of elevator doors shall be 1,500 mm.
109. Call buttons shall be installed at 1,000 mm +/- 50 mm above the finished floor.

Figure D.109

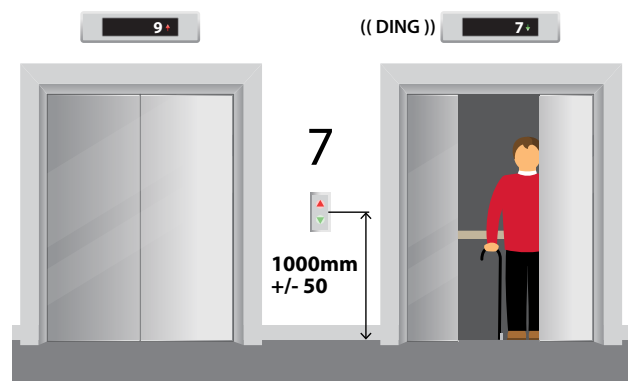

### AN AUDIBLE SIGNAL SHALL INDICATE WHEN THE CAR HAS STOPPED AT EACH FLOOR

110. Call buttons shall be located on each wall between elevators and shall be easily identifiable by colour contrast and raised symbols.

Figure D.110



- 111. Call buttons shall protrude to enable a user to push with any part of the hand.
- 112. Tactile signage with large Arabic numerals and letters conforming to Appendix E of ASME A17.1/Canadian Standards Association B44 shall be installed on both sides of the elevator doors opening in the elevator lobby.

Explanation: Tactile signage is an essential requirement for people who are blind and people with vision loss to be able to successfully access buildings. ASME A17.1-2010/CSA B44-10 Appendix E outlines the requirements for accessible elevators, including door timing and car calls, dimensions of elevator cars, buttons, keypads, visible and audible indicators and emergency communications. The Alberta Building Code 2014 3.8.3.1 discusses the requirements for accessibility signs.

- 113. Elevator doors shall begin to close after minimum of 8 seconds from the fully open position.

Explanation: The Canadian Standards Association recommends a minimum period of 5 seconds to elapse before the doors start to close if it is a hall call, and 3 seconds if it is a car call, however, City of Calgary buildings and buildings on City-owned land require elevator doors to remain open for 8 seconds to accommodate people with disabilities.

- 114. Elevators shall have a minimum inside car dimension of 1,500 mm.

Explanation: A code-compliant elevator is large enough in the length dimension, but is too small in the width dimension to accommodate the turning around of a wheelchair.

Figure D.114

### ELEVATOR CAR INSIDE DIMENSIONS

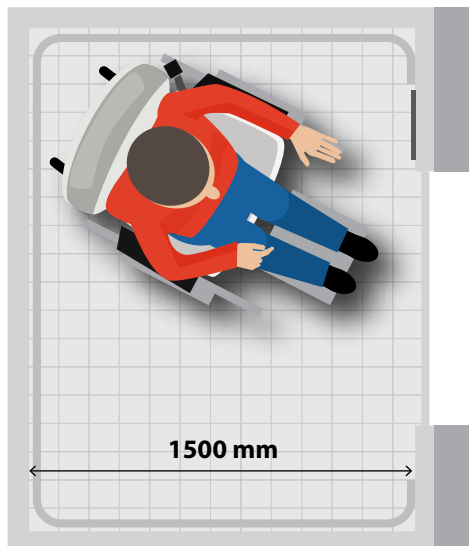

**THERE SHALL BE ENOUGH SPACE IN AN ELEVATOR CAR TO ALLOW A PERSON IN A WHEELCHAIR TO TURN AROUND**

- 115. Inside the elevator car, verbal announcements identifying the direction of travel shall be provided.
- 116. Colour contrast shall be used to differentiate the floor registration button panel from the elevator car background.

### Areas of refuge

It is essential that everyone receive the same emergency warnings and have the ability to evacuate a building safely and quickly. This includes individuals with disabilities. As additional assistance may be required from emergency responders, areas of refuge must be incorporated into the building design as an additional safety measure.

- 117. Except for open-air storage garages, Group A, Division 4 and Group F, Division 1 occupancies (all as defined in the Alberta Building Code 2014), an area of refuge shall be provided in all buildings where there is a barrier-free path of travel above or below the first storey.

Explanation: An area of refuge is a safe waiting area for evacuation. In the event of a fire an area of refuge provides a well-known place for firefighters to help anyone unable to use stairs or the elevator to exit the building.

- 118. The area of refuge shall comply with items 119 to 123 below.

- 119. Areas of refuge may be one of the following:
  - a) An elevator conforming to the Alberta Building Code 2014 3.3.1.7.(1)(a).

Explanation: The Alberta Building Code 2014 includes a requirement that the elevator is capable of reaching every floor in the building and that the electrical conductors serving the elevator are protected from fire exposure. In addition, a vestibule or a corridor surrounded by fire separations must be constructed to protect the elevator. Also, the elevator shaft must be kept free of smoke. This can be accomplished by mechanically pressurizing the elevator shaft.

The elevator and surrounding areas described in a) above shall be designed to accommodate not less than 1.5 m<sup>2</sup> of space for each person in a wheelchair and not less than 0.5 m<sup>2</sup> of space for each ambulatory attendant, at a ratio of 1:1, where the number of persons in wheelchairs is based on the occupant load of the floor area as defined in the Alberta Building Code 2014 and the Alberta Building Code 2014 Table 3.8.2.1. (If a more precise estimate of the number of people in wheelchairs is available, it should be used to size the zones.)

In all cases, the elevator and surrounding areas described in a) above shall be designed such that persons in wheelchairs will not reduce the width of egress routes to less than their required width.

b) Two fire-separated zones conforming to the Alberta Building Code 2014 3.3.1.7.(1)(b).

Explanation: These requirements from the Alberta Building Code 2014 include requirements for providing fire-separation walls around each of the compartments, smoke-tight doors and limits on travel distance to exit.

The fire separated zones described in b) above shall be designed to accommodate not less than 1.5 m<sup>2</sup> of space for each person in a wheelchair and not less than 0.5 m<sup>2</sup> of space for each ambulatory attendant, at a ratio of 1:1, where the number of persons in wheelchairs is based on the occupant load of the floor area as defined in the Alberta Building Code 2014 and the Alberta Building Code 2014 Table 3.8.2.1, and such that persons in wheelchairs will not reduce the unobstructed width of egress routes to less than their required width.

It is acceptable for a suite (as defined in the Alberta Building Code 2014) to be designed to satisfy the requirements of b) above. It shall be designed to accommodate not less than 1.5 m<sup>2</sup> of space for each person in a wheelchair and not less than 0.5 m<sup>2</sup> of space for each ambulatory attendant, at a ratio of 1:1, where the number of persons in wheelchairs is based on the occupant load of the suite as defined in the Alberta Building Code 2014 and the Alberta Building Code 2014 Table 3.8.2.1. (If a more precise estimate of the number of people in wheelchairs is available, it should be used to size the zones.)

In all cases, the fire separated zones described in b) above shall be designed such that persons in wheelchairs will not reduce the width of egress routes to less than their required width.

c) In residential occupancies, a balcony conforming to the Alberta Building Code 2014 3.3.1.7.(1)(c).

d) An exterior exit at ground level conforming to the Alberta Building Code 2014 3.3.1.7.(1)(d).

e) A ramp leading to ground level conforming to the Alberta Building Code 2014 3.3.1.7.(1)(e).

f) Not less than two horizontal exits conforming to the Alberta Building Code 2014 3.4.6.10.

Explanation: Although the sizing of the area of refuge is based on the number of persons in wheelchairs and their ambulatory attendants, the area of refuge is also intended to be used by people who do not use a wheelchair but are nonetheless unable to use exit stairs. It is acknowledged that many people in wheelchairs do not have an attendant with them at all times, and therefore it is assumed that the space allotted for ambulatory attendants might not be used in a real emergency. This unused space in the area of refuge could be occupied by other people in the building who do not use a wheelchair but are nonetheless unable to use exit stairs. Examples of horizontal exits are an exit through a firewall (as defined in the Alberta Building Code 2014) or an exit using a Plus-15 walkway.

120. All exits that can be reached by a person in a wheelchair\* shall provide a barrier-free path of travel to the exterior.

\*Exception – residential occupancies, where other requirements apply.

121. Unless it is a residential suite, the area of refuge shall be identified by directional and identification signage and the international symbol of access for disabled persons.

122. Areas of refuge shall be identified on all publicly displayed floor evacuation plans and be included in evacuation procedure documents and the building's fire safety plan.





## E. Washrooms

This section outlines The City of Calgary's Standards for accessible washrooms.

### Alberta Building Code 2014 references

- 3.3.1.9. Obstructions in Corridors
- 3.8.1.3. Barrier-Free Path of Travel
- 3.8.2.3. Washrooms Required to be Barrier-Free
- 3.8.3.1. Accessibility Signs
- 3.8.3.8. Water Closet Stalls
- 3.8.3.9. Water Closets
- 3.8.3.10. Urinals
- 3.8.3.11. Lavatories
- 3.8.3.12. Universal Toilet Rooms

#### This Section covers:

- General
- Washroom entrances
- Washroom fixtures
- Universal washrooms
- Accessible portable toilets

### General

123. Every floor shall have an accessible washroom.

Explanation: The Alberta Building Code 2014 3.8.3.1. Accessibility Signs requires appropriate signs consisting of the universal symbol of persons with physical disabilities, graphics and tactile signage specifications be used to identify washrooms. Alberta Municipal Affairs has indicated they will accept a relaxation to the character size as prescribed by the Alberta Building Code 2014 3.8.3.1.(5) a). Tactile character size can conform to CAN/Canadian Standards Association B651-12 (CAN/CSA B651-12).

Figure E.123

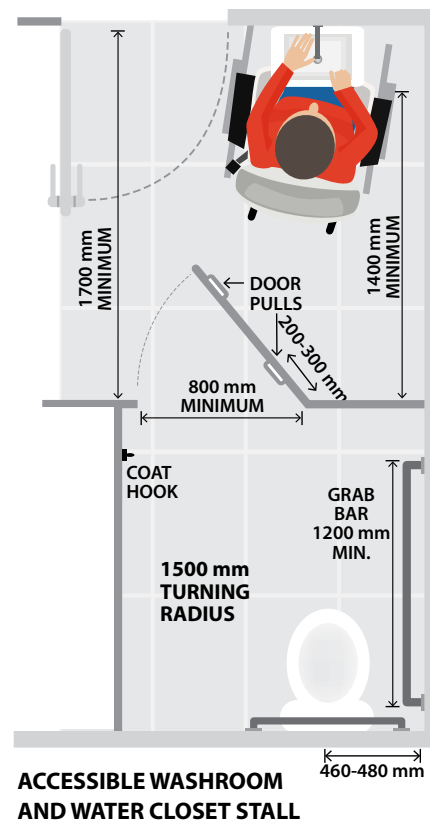



124. Washrooms provided for public use shall provide a wall-mounted sharps disposal container 1,000 mm +/- 50 mm above the finished floor and within 450 mm forward reach of a wheelchair user.

## Washroom entrances

125. Tactile signage shall be included to identify washrooms in accordance with CAN/CSA B651-12 Figure 10.

Figure E.125



126. Entrances with an L-configuration shall have a minimum depth of 1,200 mm to allow a wheelchair to turn the corner easily.

Explanation: L-shaped entrances should be as wide as possible to enable easy wheelchair access/egress.

127. Doors leading into accessible washroom stalls shall be equipped with spring or gravity hinges that slowly close the door.
128. Doors leading into accessible washrooms shall be equipped with power door operators.\*

\*Exception – residential projects and Universal Toilet Rooms.

## Washroom fixtures

129. Where provided, toilet seat cover dispensers shall be mounted 1,000 mm +/- 50 mm above floor level.
130. Where a horizontal grab bar is installed beside the toilet, the toilet paper dispenser shall be installed below the grab bar such that the toilet paper roll is mounted not less than 400 mm above the finished floor.
131. Where a grab bar with an angled portion is installed beside the toilet, the toilet paper dispenser shall be installed below the grab bar such that the end of the toilet paper roll is not less than 400 mm and not more than 850 mm above the finished floor.

Figure E.131

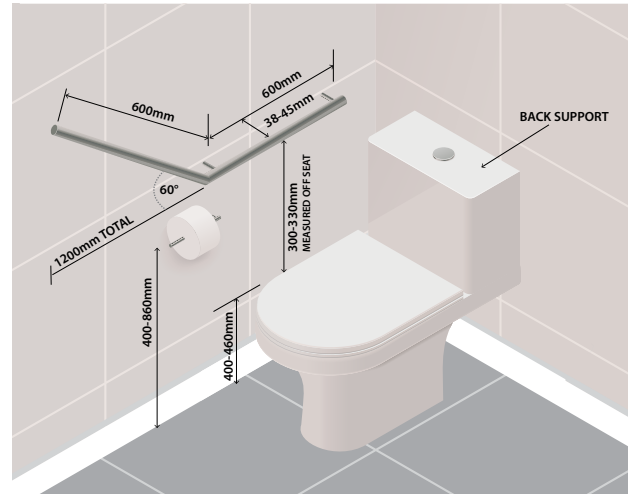

132. In all cases, the toilet paper roll should be positioned so that the end of the roll is on the wall beside the toilet and positioned within 500 mm horizontal reach of a person seated on the toilet.

133. Soap dispensers shall be mounted 1,000 mm +/- 50 mm above floor level and within 500 mm horizontal reach from the front edge of the lavatory or counter, or on a wall near the lavatory within 500 mm horizontal reach of a wheelchair user.

134. The mounting height of paper towel dispensers/hand dryers shall be 1,000 mm +/- 50 mm and in accordance with the dimensions stated in the Alberta Building Code 2014 3.3.1.9. 3) and 4), and such that the paper towel dispenser or hand dryer is within 500 mm horizontal reach of a wheelchair user.

**Note: The Alberta Building Code 2014 3.3.1.9.(3) and (4) address requirements for obstructions in corridors. In addition to the requirements of the Alberta Building Code, Standard 21 should also be observed.**

135. An automatic or single-function towel dispenser/hand dryer (requiring only one hand and only one movement to release the towel) is required.

136. Waste receptacles shall be installed such that the opening to the receptacle is at a height of 1,000 mm +/- 50 mm to the finished floor.

Note: Where possible, it is recommended that waste receptacles be recessed into the wall to ensure there are no obstructions in the barrier-free path of travel.

Figure E.136

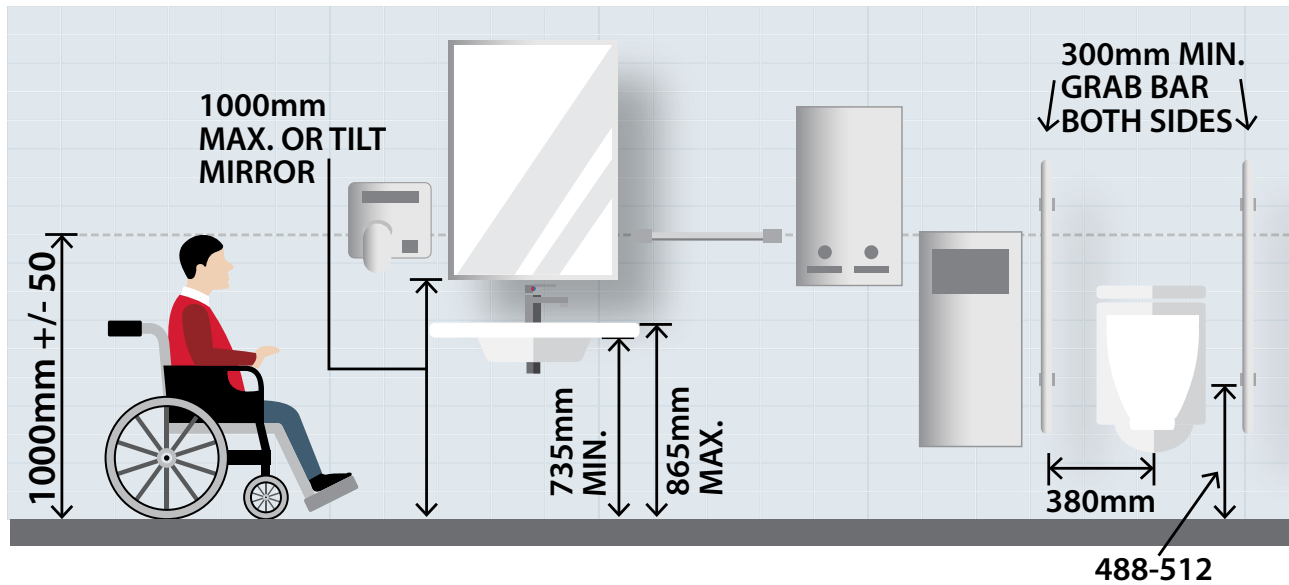

## Universal washrooms

137. Where buildings are staffed with full-time security, call buttons or press-able call strips shall be installed in all universal toilet rooms.

*Note: Call button or press-able call strips enable a washroom user to call security in the event that the washroom user falls or encounters some other situation that requires assistance.*

138. Where call buttons or press-able strips are installed, they shall be installed on the same wall as the side grab bar.

Figure E.138

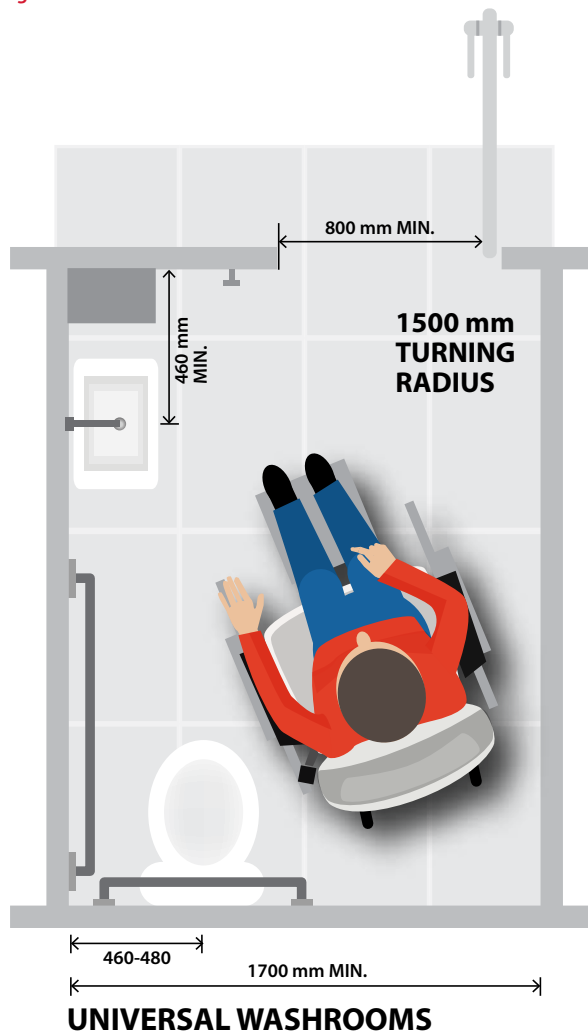

## Accessible portable toilets

139. When portable toilets are provided for outdoor events on City-owned land, at least 10 per cent of toilets provided shall be accessible with a minimum of one accessible toilet provided.



## F. Special interior features

This section outlines The City of Calgary's Standards for accessible washrooms.

### Alberta Building Code 2014 references

- 3.8.1.5. Controls
- 3.8.3.1. Accessibility Signs
- 3.8.3.7. Assistive Listening Devices
- 3.8.3.13 Shelves or Counters for Telephones
- 3.8.3.14. Counters
- 3.8.3.15. Shelves or Counters for Telephones
- 3.8.3.16 Drinking Fountains
- 7.1.2.2. Burn Prevention

#### This Section covers:

- Controls
- Faucets
- Counters
- Furniture
- Drinking fountains
- Public communications
- Transactions
- Assistive listening devices
- Signage
- Building directional maps
- Pay telephones
- Exhibits
- Illumination and acoustics

### Controls

The design and location of controls is essential to accommodate people with disabilities. Controls should be accessible to everyone that needs to use them. The controls referred to in this section include light switches, electrical outlets, thermostats, intercoms and fire alarms.

140. Controls shall be installed 1,000 mm +/- 50 mm above the floor, except fire alarm pull stations which are to be installed at 1,200 mm above the floor.

Explanation: Fire alarm pull stations must be installed as per the most recent CSA standard.

141. Controls and operating mechanisms shall be capable of being illuminated to a minimum level of 100 lux.

142. Rocker type light switches shall be used.

143. Electrical outlets shall be mounted between 600 mm and 1,000 mm above finished floor measured to the centre line of the outlet.

Figure F.143

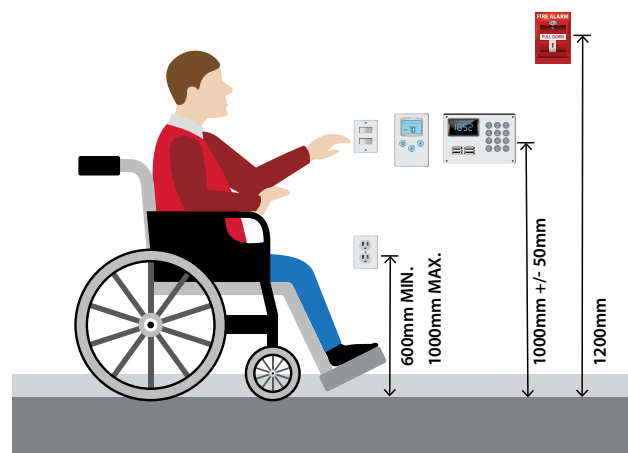

LOCATION OF CONTROLS

## Faucets

144. Automatic or lever-type faucets shall be used.

Figure F.144

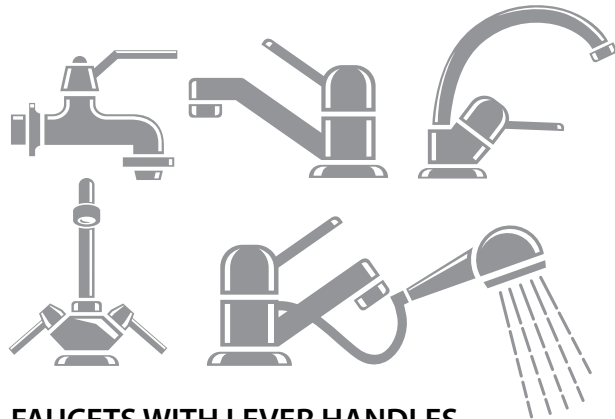

FAUCETS WITH LEVER HANDLES

## Counters

145. All products in a self-serve counter shall be within 450 mm of the edge of the counter and between 600 mm and 1,000 mm above the floor.

Figure F.145

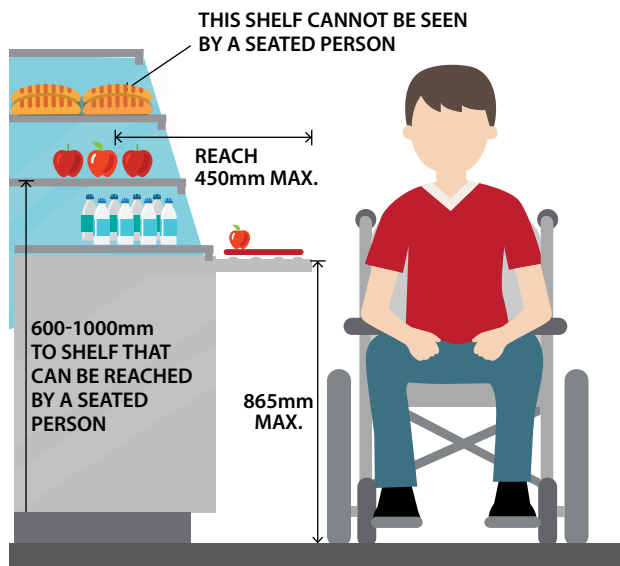

146. Counters shall contrast in colour/brightness from their surroundings, and surfaces shall have a non-glare finish.

Figure F.146

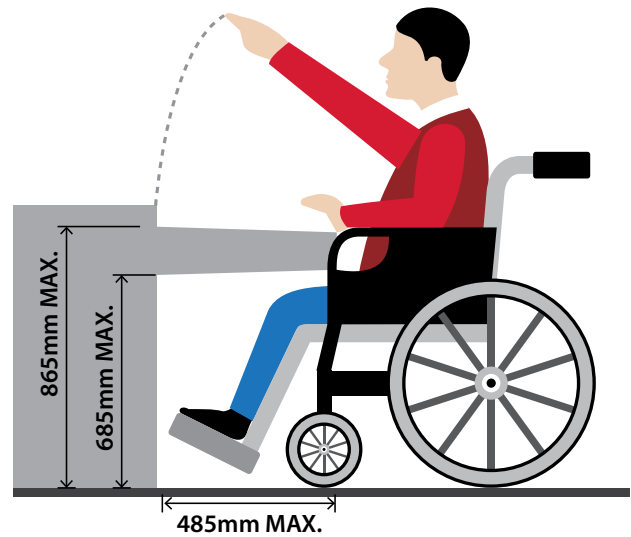

## SERVICE COUNTER

Explanation: Colour contrast and non-glare finishes can help people with vision loss locate and use counters that serve the public.

147. Where a glass partition separates customers from the service personnel at a counter, a speaker system and an assistive listening device (e.g. an FM assisted listening system, infrared system, or loop system) shall be installed.

## Furniture

148. Dining tables shall have a minimum distance of 720 mm from the floor to the underside of the tabletop, with a clear minimum depth of 350 mm underneath the table.

Explanation: Dining tables with these dimensions provide adequate knee space for wheelchair users. A variety of dining table heights is encouraged, as there are a variety of mobility devices available that will allow some wheelchair users to use higher tables.

149. Tables on raised platforms shall not be used.

Explanation: Tables on raised platform impede access for wheelchair users and people with other mobility issues.

150. Patio umbrellas in the open position shall not obstruct the barrier-free path of travel.

151. Furniture design and placement shall accommodate a 1,500 mm turning radius when people are seated at tables.

## Drinking fountains

152. In each location where a drinking fountain or fountains are installed, one fountain shall,
- have a spout opening between 750 mm and 915 mm above the finished floor.
  - have lever or push controls, located either on the front or on both sides.

Figure F.152

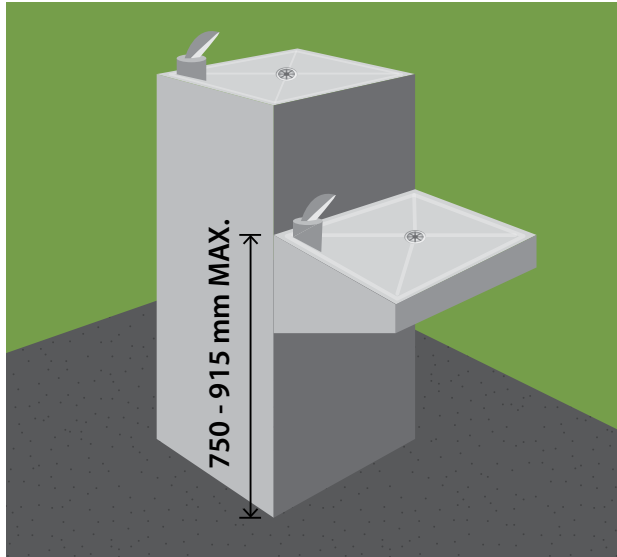

153. Where the drinking fountain is located in an alcove,
- the alcove shall be not less than 850 mm wide, and
  - the fountain shall be wall mounted with clearance beneath the drinking fountain in accordance with the dimensions stated in the Alberta Building Code 2014 3.8.3.11.(1)(c).

Figure F.153

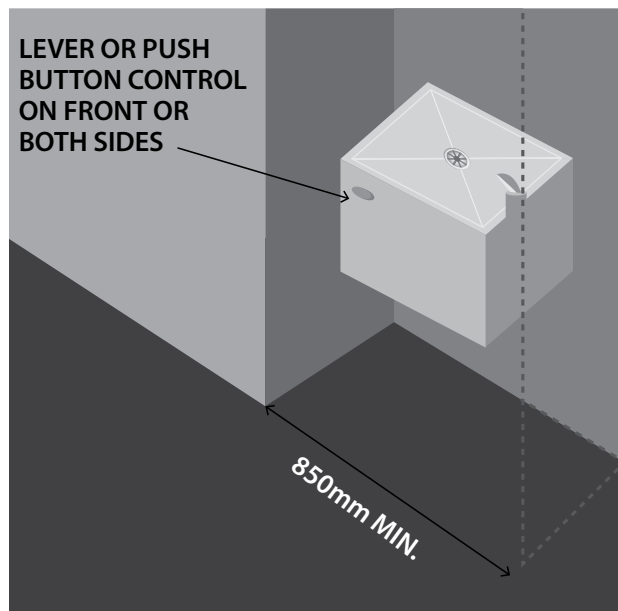

Explanation: The Alberta Building Code 2014 3.8.3.11.(1) (c) explains the clearances required beneath lavatories in barrier-free washrooms. These requirements allow a close side approach for wheelchair users, and also ensure that the drinking fountain will not be hazardous for people with vision loss using a cane.

154. Where a drinking fountain projects into the barrier-free path of travel, it shall be designed in accordance with the dimensions stated in Standard 21 of this document.

Explanation: The Alberta Building Code 2014 3.3.1.9.(3) and (4) discusses the requirements for obstructions and Standard 21 expands on these requirements.

## Public communications

It is important that buildings are simple to navigate and provide opportunities for human interaction within them. This is especially true for people with disabilities.

155. Whenever public communication is provided audibly, (i.e. narrated videos on screens or announcements on speakers), the same information should be provided visually by Closed Captioning.

## Transactions

156. When automated teller machines are provided, at least 10 per cent of machines provided shall be accessible, with a minimum of one accessible automated teller machines provided.
157. The highest operable part of an automated teller machine shall be 1,000 mm +/- 50 mm above the finished floor.
158. The knee space below an automated teller machine shall be no less than 700 mm high x 500 mm deep.
159. Interactive transaction machines such as points of sale require text and audio messages to be installed.
160. Counters equipped with induction loops shall include the internationally recognized sign for facilities for the hard of hearing (a stylized ear).

## Assistive listening devices

Many people who use hearing aids have difficulty functioning in noisy environments, especially when the speaker or speakers are at a distance. Many systems are available that can overcome the combined problems of distance and background noise. FM, infrared and induction loop systems are good examples of assistive listening systems. All three of these systems assist people who require aid in hearing without disturbing the listening enjoyment of other people.

161. An assistive listening system shall be installed at information counters.

## FM radio frequency systems

Frequency Modulation (FM) systems transmit sound on a specific frequency. The transmission is received by a small device that can be connected directly to a person's hearing aid via a Direct Audio Input. FM systems are generally recommended for large public facilities, such as airports and other transport terminals. When clearly marked, the FM broadcast area provides the traveller with an easily located listening zone, so all information, especially important announcements, is readily available.

162. Where FM systems are provided, signage with the symbol for assistive listening systems shall be provided to indicate the presence of the FM system.

Figure F.162



## Infrared systems

Instead of using sound frequencies, infrared technology uses infrared radiation to deliver sound from a transmitter to the hard of hearing or deaf person. The hard of hearing person wears a receiver or headset which works in conjunction with a loop or a T-switch in his/her hearing aid. The infrared signal will not transmit to the listener through walls or when the signal is interrupted by a moving object or person. Infrared systems are suitable for listening in both large and small groups while watching TV, listening to the radio, in meetings or other public venues. Both FM and infrared systems are available as personal listening devices, or may be provided in public venues such as meeting rooms, lecture halls, places of worship and theatres.

The infrared rays are contained within an enclosed space in which they are being used for transmission. Infrared systems should be shielded from the sun. Otherwise the strength of the transmission must be increased in order to avoid interference.

163. Where infrared systems are provided, signage with the symbol for assistive listening systems shall be provided to indicate the presence of the infrared system. Reference to the T-switch shall also be made on the sign.

Figure F.163



## Induction loop systems

Induction loop systems work with hearing aids. An induction loop wire is permanently installed (typically under a carpet or counter, around a room either on the floor or ceiling) and connects to a microphone used by a speaker. The person talking into the microphone generates a current in the wire, which creates an electromagnetic field in the room. The hearing aid telecoil picks up the electromagnetic signal when the T-switch is turned on. The volume of the signal is managed through the hearing aid volume control setting.

164. Where induction loop systems are provided, signage with the symbol for assistive listening systems shall be provided to indicate the presence of the induction loop system. Reference to the T-switch shall also be made on the sign.

Figure F.164



## Signage

Signs and symbols are an essential consideration when designing spaces for people with disabilities to navigate. Good signage provides people with vision and hearing loss direction to a variety of services, business locations, floor numbers, level locations of parking lots etc. In addition to these Standards, it is recommended that CNIB (Canadian National Institute for the Blind) standards for contrasts and colours in the accessibility guidelines and CSA (Canadian Standards Association) B651-12 be consulted for the design and placement of signage. See the appendix for more information on the CNIB and a link to their website.

165. The international symbols of access shall be used to identify all accessible facilities within a building.

Explanation: Use of the international symbols of access ensures signage can be understood by people with disabilities.

Figure F.165



### SYMBOLS OF ACCESS TO INCLUDE BRAILLE WHEN REQUIRED

166. Signage shall be located near the entrance of all buildings and along the route, to direct people upon entering and navigating through the building.

## Tactile Signs

167. The level of illumination on signs shall be at least 200 lux.

Figure F.167

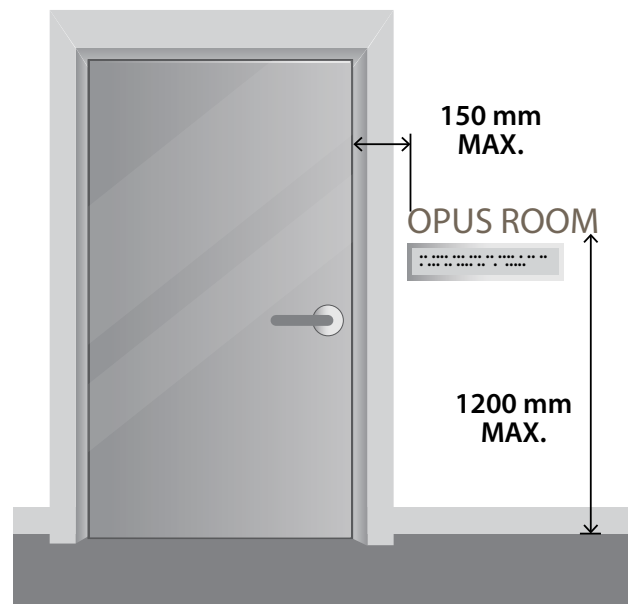

### MEETING ROOM ENTRY

168. Washrooms, kitchens, stairwells, print/copy rooms and boardrooms that can be booked through The City's online booking system shall be provided with signage including door room names and numbers, and shall conform to the Alberta Building Code 2014 3.8.3.1.(5) with tactile character size conforming to CAN/CSA B651-12.

Explanation: The Alberta Building Code 2014 3.8.3.1.(5) outlines the requirements for signage mounting height, location, braille, and colour contrast. CAN/Canadian Standards Association B651-12 outlines the requirements for tactile signage and braille. These requirements aid blind and visually impaired people to navigate their way through a building. Grade 1 braille shall be used in all cases. Alberta Municipal Affairs has indicated they will accept a relaxation to the character size as prescribed by the Alberta Building Code 2014 3.8.3.1.(5) a).



## Lettering and numbers for visual signs

- 169. Signage shall use sans serif font and Arabic numbers.
- 170. Lettering and numbers shall have a width-to-height ratio between 3:5 and 1:1, and a stroke-width-to-height ratio between 1:5 and 1:1.
- 171. The character height of letters and numbers shall be relative to the intended viewing distance as per CAN/CSA B651-12 Table 4.
- 172. Letters and numbers shall be colour-contrasted from their backgrounds.
- 173. All characters shall be clearly separated.

## Location of signs

- 174. Directional signs with the international symbols of access shall be used at focal points on main traffic routes.

Figure F.174.a



Figure F.174.b



## Building directional maps

Tactile maps and audio map systems are helpful for people with vision loss.

Good locations for these include public parks, exterior pathways, sidewalks or in the lobbies of buildings. These maps enable users with vision loss to identify their location and to get an accurate sense of distance and direction. Tilted directional maps allow wheelchair users to read and use these easily.

## Pay telephones

- 175. Where pay telephones are installed, at least one of them shall be accessible to people in wheelchairs and have variable volume control.
- 176. Where pay telephones are provided, a minimum of one and at least 10 per cent of the telephones shall be equipped with a teletypewriter (TTY).
- 177. Pay telephones equipped with TTY shall be identified with the international symbol for TTY.

Figure F.177



TTY

- 178. Accessible pay telephones shall be identified with the international symbol of access.

Figure F.178



Mobility

- 179. The length of the cord from the telephone to the handset shall be a minimum of 1,000 mm.

180. There shall be 800 mm clearance from the floor surface to the underside of any telephone enclosure or shelf. There shall be a minimum clear floor space of 800 mm in front of a telephone to allow access for people in wheelchairs.

Figure F.180

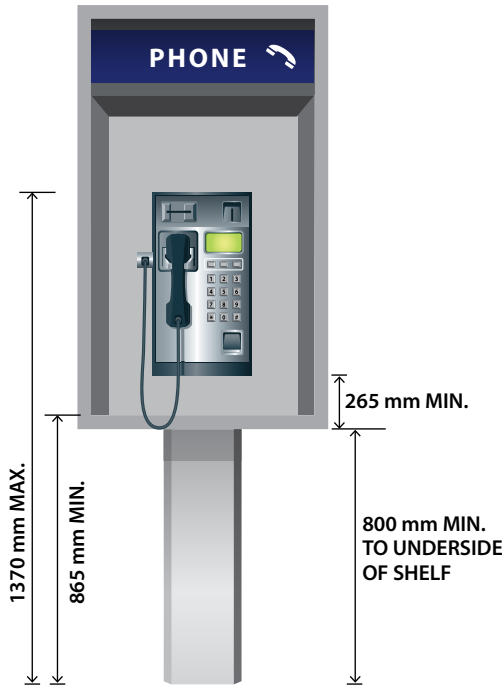

## Exhibits

It is essential that exhibits, important artifacts, labels and graphics shall be placed at an elevation that makes viewing comfortable for all visitors.

181. Exhibit displays shall be supplemented with tactile signage designed in accordance with the Alberta Building Code 2014 3.8.3.1.(5) with tactile character size conforming to CAN/Canadian Standards Association B651-12.

Explanation: Exhibition areas should be barrier-free, or an alternative method of interpreting the message should be provided, such as audio-visual presentations, large print text and/or tactile signage. The Alberta Building Code 2014 3.8.3.1.(5) outlines the requirements for signage mounting height, location, braille, and colour contrast. CAN/Canadian Standards Association B651-12 outlines the requirements for tactile signage and braille. Grade 1 braille shall be used in all cases. Alberta Municipal Affairs has indicated they will accept a relaxation to the character size as prescribed by the Alberta Building Code 2014 3.8.3.1.(5) a).

182. Displays and labels shall be located between 1,000 mm and 1,500 mm above the finished floor surface or ground level.
183. Labels on horizontal surfaces shall be tilted to allow for better viewing.

Figure F.183

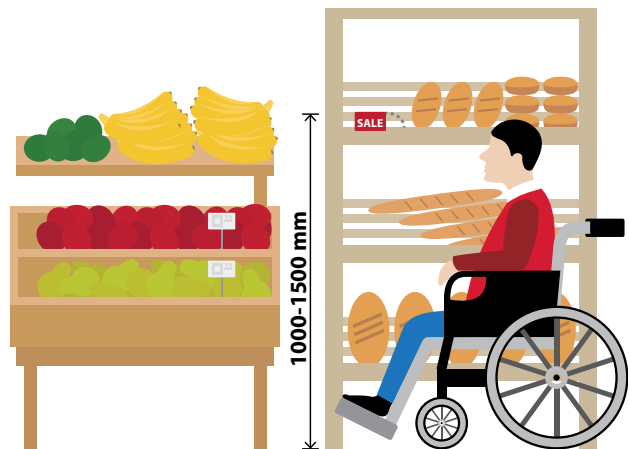

184. Display lighting fixtures shall be designed and placed in order to minimize glare and reflection.
185. Table displays shall be located between 1,100 mm and 1,300 mm above the finished floor or ground level.
186. Wall-mounted displays shall be located between 1,200 mm and 1,500 mm above the finished floor or ground level.

## Illumination and acoustics

### Illumination

Consistency in the levels of illumination is a primary concern for people with vision loss since their ability to adjust from one level to another is often slow. Please refer to Appendix A for additional guidance on lighting.

187. Illumination levels shall be increased to emphasize stairs, entrances, obstacles, information signs and outdoor areas.
188. The minimum level of illumination emitted by internally illuminated signs shall be 200 lux when measured at 1,200 mm above the finished floor. Externally illuminated signs shall be illuminated to 100 lux.

### Acoustics

Consistency of materials and colours is recommended as it provides good sensory information about the environment. The acoustic properties of materials used in interior passageways shall be considered in the design. Some sound reverberation aids people with vision loss by providing a sense of the size of the space and the location of walls or openings, while some sound absorption helps people who have hearing loss by reducing background noise. Consideration for the intended use of the space, safety, and the basic principles of Universal Design should guide design decisions that affect the acoustics of a room or space.

The minimization of ambient noise and reduction of layering of different sounds improve a person's ability to hear. People with hearing loss require spaces to be acoustically designed to reduce background noise and echoes. People with hearing loss also rely on good artificial lighting for speech reading, sign language and informative signs, so consistent levels of lighting are essential. Well planned artificial lighting may help to compensate the negative aspects of a loud or echoic environment for someone who is hard of hearing by making speech reading, sign language and information signs easier to see.

189. The heating ventilation air conditioning system (HVAC) shall be designed to consider the acoustic needs of the space.

***Note: If possible, switches may be installed to allow noisy items such as fans to be turned off and ensure people with hearing loss can communicate effectively.***

190. Speakers (except those required for the fire alarm system) shall not be placed near important areas of in-person communication, such as above information or service desks.





## G. Buildings with special requirements

This section outlines The City of Calgary’s Standards for accessible washrooms.

### Alberta Building Code 2014 references

- 3.8.3.8. Water Closet Stalls
- 3.8.4.4. Kitchens
- 3.8.3.12. Universal toilet rooms
- 3.8.3.13. Showers
- 3.8.4. Adaptable Dwelling Units
- 7.2.3.18. Pool Markings

#### This Section covers:

- G.1 Places of assembly
- G.2. Recreation facilities
- G.3. Universal dwellings
- G.4. Calgary Transit
- G.5. Construction sites

### Places of assembly

For parking, exterior paths of travel, entrances, interior paths of travel, special interior features and washrooms, refer to sections A, B, C, D, E and F respectively.

#### Seating

191. The number of spaces for wheelchair users shall be as follows:

Number of fixed seats in seating area	Number of spaces for wheelchair users
2–100	4
101–200	5
201–300	6
301–400	7
401–500	8
501–900	9
901–1300	10
1,301–1,700	11
Each increment of up to 400 seats in excess of 1,700	2 additional spaces

Explanation: The Alberta Building Code 2014 Table 3.8.2.1. outlines the number of spaces required for wheelchair users. City of Calgary spaces are increased by at least two spaces per number of fixed seats to accommodate an increase in the anticipated population of wheelchair users in the future.

Figure G.191

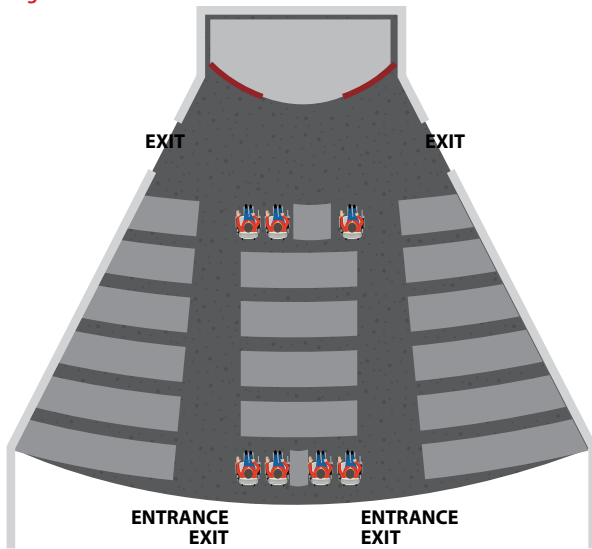

**ACCESSIBLE SEATING DOES NOT INTERFERE WITH EGRESS FROM OR ACCESS TO OTHER SEATS**

192. Places of assembly shall be designed to limit glare.  
 Explanation: If a speaker/presenter is in front of a window or with lights shining from behind the speaker, this will create glare and should be avoided.

**Recreation facilities**

For parking, exterior paths of travel, entrances, interior paths of travel, special interior features and washrooms refer to sections A, B, C, D, E and F respectively. Spectator seating in recreation facilities must be provided in accordance with Section G - Seating in Places of assembly.

**Universal self-contained change rooms**

Individual change and/or shower rooms for people with disabilities allow family members or caregivers of the opposite gender to provide assistance with dignity and respect. These facilities may also be used by people who, for whatever reason, require additional privacy than what the gender-specific change rooms provide. The Universal self-contained change room shall be planned as an integral part of the changing area and located in proximity to the other change rooms. Universal self-contained change rooms are also known as assisted needs change rooms.

193. At least one universal self-contained change room shall be provided in all recreation facilities with public change rooms.  
 Explanation: Universal self-contained change rooms are required in, but not limited to, gymnasias, arenas, indoor swimming pools and exercise/fitness centres.

194. Self-contained universal change rooms shall conform to the Alberta Building Code 2014 Clauses 3.8.3.12.(1)(a), (b), (g) and (i).

Explanation: The Alberta Building Code 2014 3.8.3.12.(1)(a), (b), (g) and (i) outlines the access, door and spatial requirements for universal toilet rooms.

Figure G.194

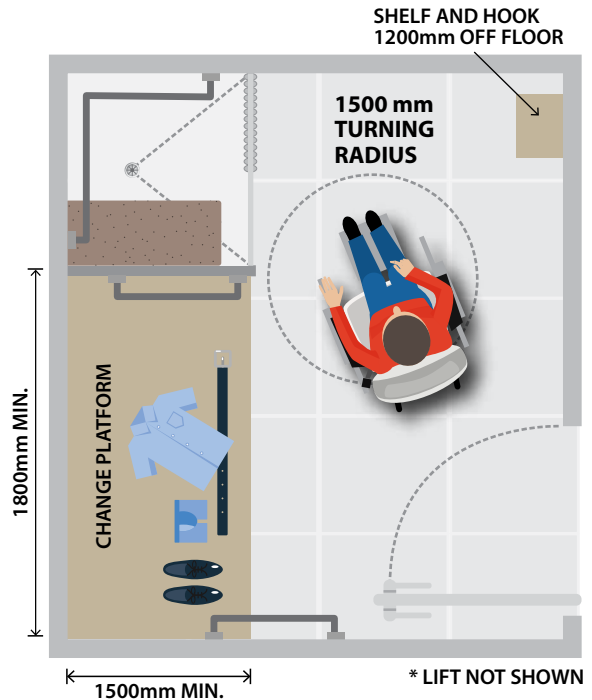

**ACCESSIBLE CHANGE ROOM AND SHOWER**

195. Self-contained universal change rooms shall have a shower conforming to the Alberta Building Code 2014 3.8.3.13.(1).

Figure G.195

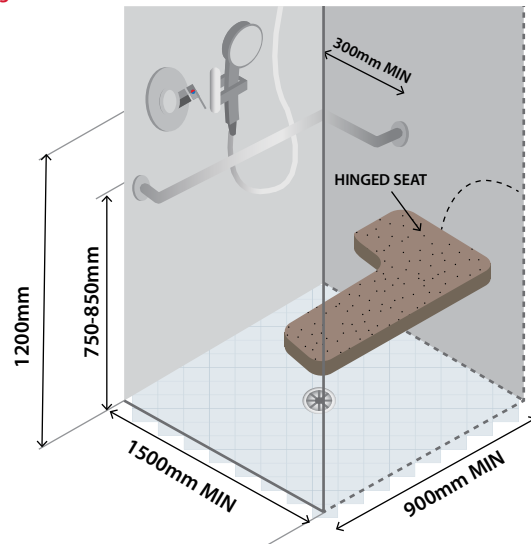

Explanation: The Alberta Building Code 2014 3.8.3.13.(1) outlines special and design requirements for accessible showers.

196. Water/shower wheelchairs shall be provided for use in the barrier-free shower and be available to provide access from the change room shower area to the pool deck, including for ramp access into swimming pools, as needed.
197. The slope of the shower floor to drain shall be a maximum 1:20 (five per cent).
198. If equipped with a water closet, the water closet shall conform to the Alberta Building Code 2014 3.8.3.12.(1) (c), (d), (e), (f) and (h).  
Explanation: The Alberta Building Code 2014 3.8.3.12. (1)(c), (d), (e), (f) and (h) outlines the spatial and design requirements for water closets within universal toilet rooms.
199. Self-contained universal change rooms shall have an elevated changing platform not less than 1,500 mm wide, 1,800 mm long and 450 mm above the finished floor.
200. A grab bar conforming to the Alberta Building Code 3.8.3.8.(2)(c), (d) and (e) shall be installed to serve the elevated changing platform.  
Explanation: The Alberta Building Code 2014 3.8.3.8.(2) (c), (d) and (e) outline the diameter, clearance and minimum resistance to an applied force that is required of grab bars.
201. The grab bar shall be L-shaped with 760 mm long horizontal and vertical components mounted with the horizontal component 630–690 mm above the floor, and the vertical component 150 mm in front of the elevated changing platform.
202. Self-contained universal change rooms shall have a lift that is either a motorized ceiling mounted lift or a mobile lift that accesses the elevated changing platform, the shower, an open space not less than 2,000 mm in diameter, and the water closet, if a water closet is provided.

## Public change rooms

203. At least one private accessible cubicle, shower and washroom shall be provided in each gender-specific change room and conform to the Alberta Building Code 3.8.3.13 for showers and 3.8.3.9 for water closets.  
Explanation: A secluded accessible change cubicle (with a shower and washroom) within a gender-specific change room provides a choice for people, with any disability who are independent, yet want a more inclusive change setting within the recreation facility than the Universal self-contained change room
204. If benches are installed, a section of an accessible bench shall be installed with seats that are a minimum 1,065 mm long, 450 mm – 500 mm high, and 510 mm – 610 mm deep. The accessible bench shall be located adjacent to the accessible lower lockers.  
Explanation: Benches that are wide enough may assist people who use wheelchairs to transfer onto the bench and stay upright. This is particularly helpful for people who cannot touch the ground with their feet. Grab bars may also be installed but should not interfere with transfer to the bench.
205. If equipped with lockers, lower lockers shall be provided and installed with latches that are easily operable with one hand and are within 400 mm – 1,200 mm vertical reach of a wheelchair user.  
Explanation: Lockers should be available for use by someone in a wheelchair and the lower height ensures access. Latches that are easy to manipulate ensure people with limited hand strength can use them.
206. A 1,500 mm wide path shall be provided within each section of lockers and shall have a clear floor space of 1,500 mm turning radius directly in front of the lower lockers.  
Explanation: Benches in front of lockers block the access, so a clear space in front of the accessible lockers provides a changing area large enough for wheelchair manoeuvring.
207. A minimum 1,200 mm wide barrier-free path of travel shall be provided throughout the change room.  
Explanation: Change rooms have different use areas (e.g. lockers, changing areas, washrooms, showers). This minimum 1,200 mm wide path of travel ensures access to all areas and enables two people (one person using a mobility aid and one ambulatory person) to pass each other easily.

## Exercise areas

208. Exercise equipment shall include “inclusive equipment” useable by people with and without disabilities.
209. All exercise equipment that could reasonably be used by a person in a wheelchair shall be accessible by a level, 1,500 mm wide barrier-free path of travel and shall have a clear floor space that is not less than 920 mm x 1,220 mm beside the equipment that requires a transfer.

Explanation: Properly positioned handrails facilitate transfer to and from exercise equipment. A level 1,500 mm wide path ensures there will be sufficient wheelchair clearance to exercise equipment, and a clear floor space beside it facilitates the transfer process.

210. Raised exercise platforms shall be available as an alternative to stretching on the floor for wheelchair users and other users with reduced mobility.

*Figure G.210*



**RAISED EXERCISE PLATFORM**

## Aquatic pools

Accessible swimming pools, hot tubs and steam rooms can be essential for people with disabilities, who may rely on aquatic activities as a form of rehabilitation or exercise to benefit their health and well-being.

211. A zero depth/sloped entry or ramp with handrails shall be provided for entry into the swimming pool. Alternate means of pool entry may be deemed acceptable if demonstrated to be inclusive in daily practice.

Explanation: If a pool does not have a zero depth/sloped entry the method of pool entry shall include a ramp with handrails. If a pool lift is considered in the planning stages in which a ramped access can be included in the design, then a ramp is preferred because it will better serve the varying needs of people getting into and out of a swimming pool. The goal is to have a sloped access as the means of entering/exiting all new pool basins.

*Figure G.211.a*

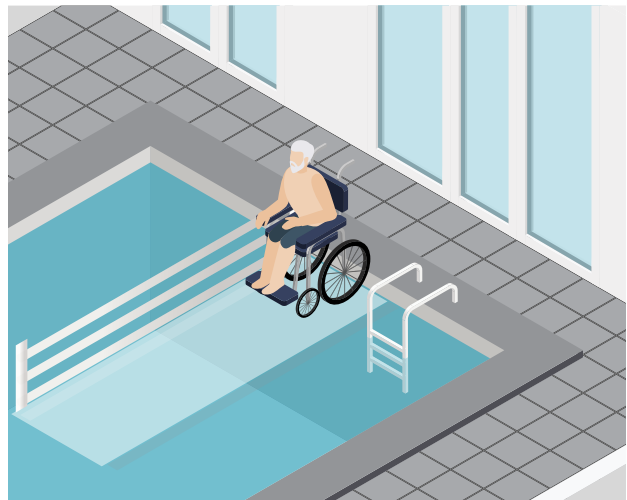

*Figure G.211.b*

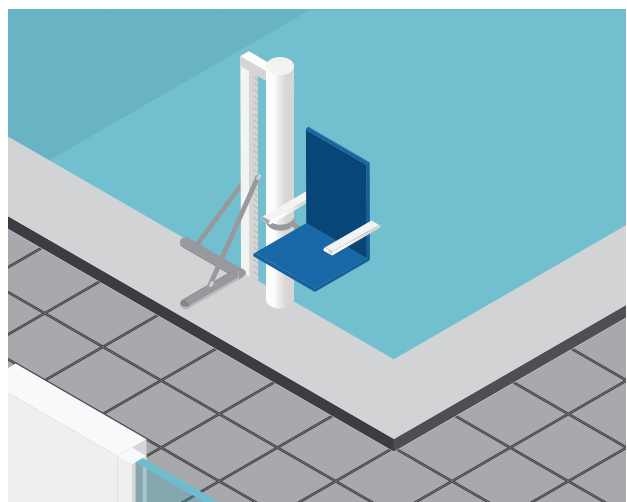

- 212. If a ramp is installed, it shall be installed at the shallow end of the pool.
- 213. Pool markings required by the Alberta Building Code 2014 7.2.3.18. shall also be provided in a contrasting texture.

Explanation: The Alberta Building Code 2014 7.2.3.18. outlines the design requirements for pool markings. The Access Design Standards also requires pool markings to contrast in texture. This tactile feature offers swimmers with vision loss an additional level of information.

- 214. If a pool has a hot tub, a ramp shall be provided for entry into the hot tub.

Explanation: All amenities should be available for use by people with disabilities with the goal to allow universal access into the body of water. The method of entry to all new hot tubs shall include a ramp as the accessible means of entering/exiting.

- 215. If a pool has a sauna/steam room, a 1,500 mm turning radius shall be provided inside.

Explanation: All amenities should be available for use by people with disabilities and a 1,500 mm clear floor space allows for wheelchair manoeuvring. Additional information: People utilizing a sauna/steam room with a wheelchair may transfer onto the bench and park the wheelchair outside the room so it does not become hot. A clear floor space inside must be positioned to allow a transfer and then a space to park the wheelchair outside in close proximity to the sauna entrance must not impede the route of travel.

## Ice rinks and dry slabs

It is important that ice rinks be designed with the consideration of sports such as sledge hockey played by people with disabilities, and for spectators, visitors and staff who may also have a disability.

- 216. In ice rinks where the demand and usage of an amenity for the sport of sledge hockey is planned for, based on needs and preference studies, Standards 217 – 223 below shall be provided.

**Note: Please contact Recreation for more information on sledge hockey amenities.**

- 217. Barrier-free access to player's benches shall be provided in ice rinks.
  - 218. Player's benches and penalty boxes shall have clear Plexiglass in the lower part of the boards.
- Explanation: When used in place of white boards in front of the player's benches and penalty boxes, a clear Plexiglass ensures sledge hockey players can see the ice.
- 219. The player's benches must have two doors, 910 mm wide each, leading onto the ice surface.

Figure G.219

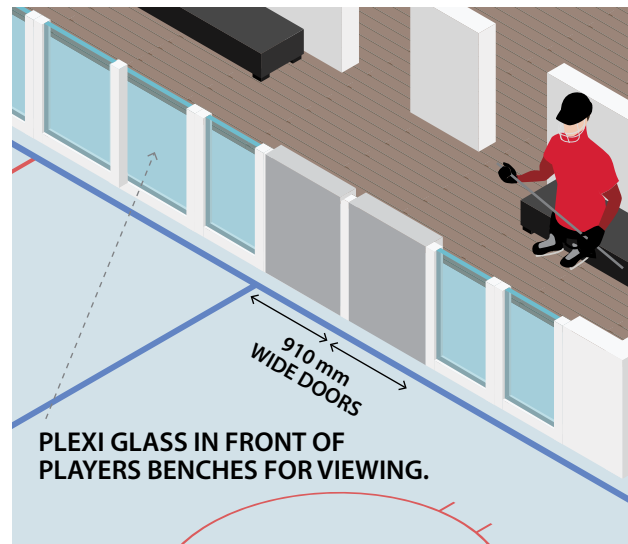

- 220. The player's bench areas shall be designed to have removable benches or shall have a minimum of 900 mm between the bench and surrounding boards or walls.

Explanation: Removable benches provide room to manoeuvre sledges.

- 221. A removable surface such as Plexiglass that can be placed between the change rooms and the ice surface, shall be provided.

Explanation: This will allow sledge hockey players the ability to glide from the change rooms to the ice surface.



222. Level access onto the ice surface shall be provided from player's benches, penalty boxes and other access points.

Explanation: A minimal threshold onto the ice allows for quick access and egress, required when changing players, without needing assistance or lifting by another person.

223. A 1,500 mm wide space shall be provided behind the player's bench in ice rinks.

Explanation: This space allows coaches or parents in a wheelchair to manoeuvre comfortably behind the bench.

### **Golf courses and driving ranges**

224. An accessible pathway shall connect all key elements of the golf course, such as from the parking lot to the clubhouse, to adjacent cart paths between tee boxes, fairways, putting greens, and driving range.

- a. The surface of the pathway shall be firm and stable.
- b. If there's curbing on the golf cart path for the purpose of preventing golf carts from entering certain portions of the fairway, or to reduce erosion, openings of at least 1,500 mm wide shall be provided at safe intervals.
- c. Refer to Section B Exterior Paths of Travel for the minimum width requirements of the pathway.

Explanation: An accessible path of travel designed to provide access to all the elements, spaces and buildings within the site boundaries of the golf course ensures people with mobility disabilities can participate in playing golf. Generally, outdoor surfaces such as pavement, stones, crushed and compacted stone, and rubberized surfaces are considered to be firm and stable. Sand, pea rock and wood chips/mulch are not firm and stable and should not be used. If required, applicants may be asked to demonstrate a chosen product is firm (does not compress underfoot) and stable (endures weather conditions and does not shift).

### **Athletic parks**

225. An accessible pathway shall connect all elements of an athletic park, such as the parking, sports fields, baseball diamonds, running tracks, spectator areas and washrooms, and:

- d. The surface of the pathway shall be firm and stable.
- e. Refer to Section B Exterior paths of travel for the minimum width requirements of the pathway.

Explanation: An accessible route of travel designed to connect all the elements, spaces and buildings within the site boundaries of the athletic park ensures people with disabilities can participate in the outdoor sport(s) amenities. If required, applicants may be asked to demonstrate a chosen product is firm (does not compress underfoot) and stable (endures weather conditions and does not shift).

### **Universal dwelling units**

It is essential that residential suites, including single and multifamily homes, are liveable for people with and without disabilities. A universal home allows people to move around and live without any restrictions within their space. A home should be flexible enough to accommodate people with all types of disabilities, and provide a diverse comfort level for any of its occupants.

The Alberta Building Code 2014 requires adaptable dwelling units when the project has received funding from the Alberta government. STANDATA 06-BCI-010 defines adaptable as a dwelling unit that "has been designed to allow it to be altered to make the unit consistent with the principles of barrier-free design."

The Access Design Standards extend these requirement to projects owned and/or operated by The City of Calgary. While new construction is required to conform to these Standards, it is expected that complete conformance with these Standards may not always be possible when renovations are undertaken. On a case-by-case basis, the appropriate City of Calgary business units and the Advisory Committee on Accessibility should be consulted to determine the required level of conformance.

Affordable Housing (under Community Services) builds projects that provide safe and affordable housing solutions to the citizens of Calgary. Calgary Housing Company is the City-owned corporation that operates and manages these units for low-income Calgarians. While Affordable Housing does build adaptable units, it is unable to accommodate individuals that need a high level of care (*i.e.* a level of care that would require a purpose built facility).

All standards under the heading “Universal design elements” are required to be incorporated into every housing unit that is required to be adaptable. All standards identified as “Barrier-free design elements” are required to be incorporated if the person living in a particular unit has a disability that would require those features to be installed. Not every barrier-free design element will always be required. For example, if a person with vision loss wants to live in an adaptable unit, barrier-free design features benefiting people with mobility loss may not be necessary.

See sections A – F of these Standards for vehicular access, exterior paths of travel, entrances, interior paths of travel, washrooms and special interior features.

#### The Alberta Building Code 2014 references

- 3.8.4.1. Application
- 3.8.4.2. General Accessibility
- 3.8.4.3. Bathrooms
- 3.8.4.4. Kitchens

## Standards

### General accessibility

226. The number of adaptable units to be provided shall be in accordance with the Alberta Building Code 2014 3.8.4.1.

Explanation: The Alberta Building Code 2014 3.8.4.1. outlines the number of adaptable dwelling units required as a ratio to the number of units in a given project.

227. Automatic or lever faucets shall be used in all barrier-free dwelling units.

228. Audio wall thermostats shall be installed in designated units for people with vision loss.

229. Window hardware shall be installed within 450 mm forward reach of a wheelchair user.

### Entryways

230. Accessible closet spaces for outerwear and shoes shall be provided.

231. Closets shall have doors with D-shaped handles.

232. Closet rods shall be 1,000mm +/- 50 above the finished floor.

233. Closet shelves shall be 1,200 mm above the finished floor.

Explanation: In all cases where shelves are provided, the Anthropometrics of Mobility Aid Users as per Annex B of Canadian Standards Association B651-12 should be considered.



## **Bathrooms**

### ***Barrier-free design elements***

234. An adjustable mirror that is not less than 610 mm wide shall be provided.
235. If provided, curbless roll-in showers shall be 1,220 mm deep and comply with the Alberta Building Code 2014 3.8.3.13.(1).  
Explanation: The Alberta Building Code 2014 3.8.3.13.(1) discusses the requirements for showers provided in a barrier-free path of travel.
236. The counter shall colour contrast with the wall background.
237. The lavatory counter shall be a minimum of 915 mm wide x a maximum of 610 mm deep.
238. Toilet flush handles shall be installed on the mount/dismount side of the toilet.
239. Blocking shall be provided behind all grab bars, towel racks and hooks.

### ***Universal design elements***

240. Toilet paper dispenser, towel bar and light switches shall colour contrast with the background finish and be installed in accordance with these Standards.
241. Towel bars shall be installed not more than 1,100 mm above the floor and must be within a clear reach of 450 mm from where a wheelchair can be positioned.
242. Hooks shall be installed in conformance with the Alberta Building Code 2014 3.8.3.8.(1)(e).  
Explanation: The Alberta Building Code 2014 3.8.3.8.(1)(e) outlines the mounting height and maximum projection of a hook for use in a bathroom.
243. Before installing a bathtub, a floor drain for a curbless shower shall be installed underneath.  
Explanation: The installation of a floor drain allows for a curbless shower to be installed later, if desired.

## **Kitchens**

### ***Barrier-free design elements***

244. An accessible oven with a door that opens toward the side, where the bottom of the door is mounted between 400 mm and 860 mm above the finished floor shall be installed.
245. The refrigerator door shall swing 180 degrees.
246. Side-by-side fridges or bottom mount freezers shall be provided.
247. Space for a microwave shall be provided at counter height with knee space below, or in a shelf located so that the microwave door will be between 400 mm and 860 mm above the finished floor.
248. Electrical outlets and light switches shall be located at the front of counters.  
Explanation: This ensures that important controls will be at an appropriate height for wheel chair users.
249. A work surface on at least one side of the cook top, sink, dishwasher and oven shall be provided.

### ***Universal design elements***

250. Cabinet and drawer pulls shall be provided with D-shaped handles and shall be of a contrasting colour to the cabinet surface.
251. Drawers with full extension slides shall be installed.
252. Lighting shall be installed under upper cabinets. This lighting shall be on a separate switch from the general lighting in the kitchen.
253. A heat-resistant shelf shall be installed under the oven. The shelf shall be the same width as the oven and pull out at least 250 mm.
254. A heat-resistant shelf shall be installed under the microwave. The shelf shall be the same width as the microwave and pull out at least 250 mm.  
Explanation: Additional counter or shelf space must be provided to allow food items to be removed from the microwave safely.

## Laundry rooms

### **Universal design elements – common laundry rooms**

- 255. Washer and dryer have front-mounted controls, with side-hinged doors and door swings of 180 degrees.
- 256. The interior of the dryer shall be illuminated.

### **Universal design elements – common and in-suite laundry rooms**

- 257. Working spaces shall be 600 mm deep x 765 mm – 850 mm high, with knee space below conforming to the Alberta Building Code 2014 3.8.4.4.(3)  
  
Explanation: The Alberta Building Code 2014 3.8.4.4.(3) outlines the spatial requirements for knee spaces below working spaces. This space allows wheelchair users the ability to conveniently fold laundry.
- 258. At least one dryer shall be installed at floor level.

### **Barrier-free design elements – in-suite laundry rooms**

- 259. Washer and dryer must have front-mounted controls, with side-hinged doors and door swings of 180 degrees.
- 260. The interior of the dryer shall be illuminated.

### **Universal design elements – in-suite laundry rooms only**

- 261. Working spaces shall be 600 mm deep x 765 mm – 850 mm high, with knee space below conforming to the Alberta Building Code 2014 3.8.4.4.(3).  
  
Explanation: The Alberta Building Code 2014 3.8.4.4.(3) outlines the spatial requirements for knee spaces below working spaces. This space allows wheel chair users the ability to conveniently fold laundry.
- 262. Space shall be provided to store laundry supplies at no more than 1,200 mm above the finished floor.

## Bedrooms

### **Barrier-free design elements**

- 263. If shelves are provided inside the bedroom closet, they shall be provided and mounted between 400 mm and 1,200 mm above the finished floor.

### **Universal design elements**

- 264. Telephone jacks shall be installed between 450 mm and 1,200 mm above the finished floor.
- 265. Closets shall have a clear opening of a minimum 850 mm, with a 1,500 mm turning radius in front.
- 266. If using a sliding closet door, D-shaped handles are required.
- 267. Closet rod to hang clothing shall be provided at 1,200 mm high.
- 268. A minimum 920 mm clearance on both sides and at the foot of the bed shall be provided.  
  
Explanation: 920 mm wide clearance ensures a barrier-free path of travel.

## Alarms

- 269. Visual signal devices for doorbells shall be installed.

## Calgary Transit

People with disabilities should not have to rely solely on specialized transportation services for travel. Having an accessible public transit system relieves the burden on those services. The City of Calgary recognizes the needs of community members with disabilities related to public transit, and has implemented design changes to accommodate them. With an accessible transit system, people with disabilities will have alternate means of travel.

### References

1. City of Calgary Transit Friendly Design Guide
2. Transit-Oriented Development Policy Guidelines
3. Calgary Transit LRT Design Guidelines
4. 2015 Draft Calgary Transit BRT and Transitway Design Guidelines

## Ramps

– see Section B of these Standards.

## Elevators

– see Section D of these Standards.

## Public communications and pay telephones

– see Section F of these Standards.

## General

270. Clear signage indicating the location of the accessible entrance to the station and platform, help phones and an elevator shall be provided.
  271. Nosings of stairs and ramps shall have yellow colour contrast and texture.
  272. All handrails shall be “accessible blue” colour (RAL5003) and installed in conformance with Section B of these Standards.
  273. Transit buildings with two or more doors at their entrance should alternate door opening between left- and right-hand operation, unless analysis by the consultant deems that, due to prevailing winds doors shall only be opened in one direction.
- Note: This is an exception to the requirement for alternating door swing in Section C of these Standards.*
274. A barrier-free path of travel 1,500 mm wide is required throughout the station site (e.g. parking stalls, bus stops, LRT station, LRT platform – anywhere the public can go).
  275. Rail crossings shall be smooth and level across the tracks and provide visual and auditory cues.
  276. Benches shall have “accessible blue” (RAL5003) colour contrast on the ends and posts. The posts for benches shall be painted “accessible blue” up to 220 mm above the finished floor or ground level.
  277. All interior and exterior lighting shall minimize glare and backlit areas.

Explanation: Lighting shall be visible by others without restriction to natural surveillance.

## Communication and security

278. A pay telephone shall be provided and designed in compliance with Section F of these Standards.
279. Audio and visual announcements of delay of service and emergencies shall be provided.

## Transit shelters

Transit shelters serve as drop-off points in an accessible transit system.

280. Shelters shall be set back from the curb a minimum 1,500 mm to allow sufficient space for pedestrian circulation and drifting snow.
281. A barrier-free path of travel shall be provided from a pedestrian walkway and/or drop-off point to the entrance of a transit shelter.
282. Transit shelters shall have a minimum 1,500 mm x 1,500 mm space at the entrance of the shelter.
283. Transit shelters with glass panels shall have decals or a continuous “accessible blue” (RAL5003) colour line.
284. Glass panels with decals or a continuous “accessible blue” line shall be 1,350 mm above the finished floor or ground surface, and a minimum width of 150 mm.

## Platforms

285. LRT and BRT platform furniture shall be a minimum of 2,400 mm from the edge of the platform.

*Figure G.285*

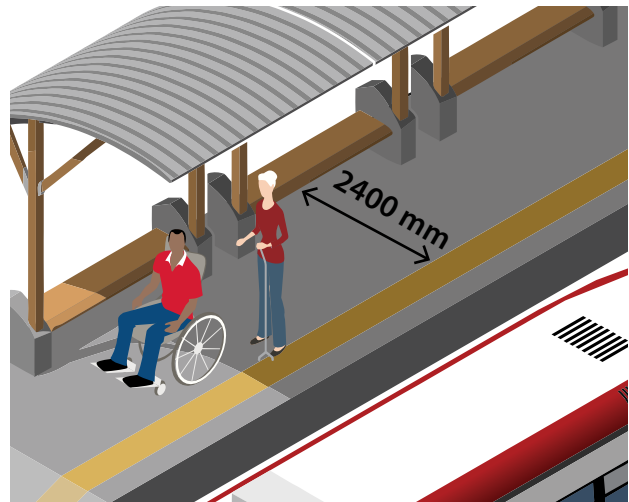

286. Yellow Americans with Disabilities Act tile strips (better known as ADA tile strips) shall be 600 mm wide at LRT and BRT platform edges.

*Note: Please contact Calgary Transit for more information on the requirements for tactile warning strips.*

287. If a pedestrian bridge connects to a platform, the bridge shall be a minimum 1,650 mm wide.

## Construction sites

Contractors and owners should reference The City of Calgary’s “Practical Guide for Construction Sites in The City of Calgary” handbook.



## Appendix

### A-99

#### CoLATE Principles

Five Basic Principles for Safe and Effective Environmental Design for People with Visual Disabilities were developed by Mark Iantkowiak in 2003 and are best remembered by using the acronym CoLATE.

**Co** – Colour and contrast

**L** – Lighting

**A** – Audible cues

**T** – Tactile cues

**E** – Ergonomics

#### Co – Colour and contrast

Effective use of colour and contrast designs can enhance safe orientation and mobility of people with visual impairments. Walls should be in contrast with flooring, furniture in good contrast with carpeting and surrounding walls, colour/contrast cues can be used for wayfinding or even to indicate important fixtures such as doorknobs, door frames, drinking fountains etc.

#### L- Lighting

Lighting (or perhaps more aptly phrased as illumination, since we are referring to the actual way an area is illuminated rather than, necessarily, the source or type of lighting) is a vital consideration in providing safe access/egress and use of a structure or outdoor area. Designers often use accent lighting to highlight a decision making point or a point of interest. Even back-lit lighting is used to highlight certain points of interest or for information purposes. Such lighting designs are not desirable for most people with visual impairments. Most eye conditions require a well-distributed, constant level of lighting. Back-lit areas or areas where glare is present, or proceeding from a dark lit area to a brightly lit area only exacerbate orientation and mobility for people with visual impairments.

#### A – Audible cues

Audible cues are also a vital consideration for people with varied levels of vision (particularly for those individuals with no vision at all). One can align their path of travel according to sounds they know the location of, they can relate the distance from various objects by sound, or even track where they are located within a structure by knowing a sound cue within a structure. A water fountain which gives off a distinctive sound within a shopping mall is an example of an audible cue.

## T – Tactile cues

Tactile cues are a parallel consideration to audible cuing. One might align oneself according to the direction of a wall, curb or planter if there is some indication that such a tactile entity is used in a consistent way within a structure. Tactile cues may also be used at decision-making points for wayfinding (e.g. different textures on floor surfaces; or textures on walls; or signs in relief placed consistently next to doorways; or even railings with different textures when approaching changes in elevation).

## E – Ergonomics

Although ergonomics is commonly defined as the study of people in relation to their working environment, the following is a broader application of term. Ergonomics within the context of safe orientation and mobility for people with visual disabilities is actually meant to allude to the logical layout and usage of a structure or area.

Simply by reasoning, then, one might assume there will be washrooms adjacent to an eating area; or seating next to a reception area; or public telephones close to an entry vestibule to a major building etc. The way the walls, doors and various fixtures are oriented to one another, as well, might be an ergonomic consideration. Generally, only when a structure is planned with right angles, logically situating decision and destination points for wayfinding, and logically situating facilities according to usage or complementary considerations might the safe orientation and mobility of people with visual disabilities be met.

## A-164

The CNIB online document “Clearing Our Path” provides information on creating accessible environments for people with vision loss. This second edition of “Clearing Our Path” is enhanced with information from new research, new international standards, incorporates opportunities that new technology offers and also observes the seven principles of universal design.

<http://www.clearingourpath.ca/>

## Universal design

The concept of universal design was developed by Ronald Mace, the founder and former program director of The Center for Universal Design at North Carolina State University. Universal design can be thought of as a living, evolving approach to design that considers the varied abilities of users. A working group comprised of architects, product designers, engineers and environmental designers defined seven principles of universal design in 1997. The seven principles are:

- 1. Equitable Use:** The design is useful and marketable to people with diverse abilities.
- 2. Flexibility in Use:** The design accommodates a wide range of individual preferences and abilities.
- 3. Simple and Intuitive Use:** Use of the design is easy to understand, regardless of the user’s experience, knowledge, language skills, or current concentration level.
- 4. Perceptible Information:** The design communicates necessary information effectively to the user, regardless of ambient conditions or the user’s sensory abilities.
- 5. Tolerance for Error:** the design minimizes hazards and the adverse consequences of accidental or unintended actions.
- 6. Low Physical Effort:** The design can be used efficiently and comfortably with minimum fatigue.
- 7. Size and Space for Approach and Use:** Appropriate size and space is provided for approach, reach, manipulation, and use regardless of user’s body size, posture, or mobility.

It is encouraged that designers and code users consider the Seven Principles of Universal Design when applying the Access Design Standard.



# Glossary

- Non-glare finish – Matt or satin finishes are considered non-glare and do not present the issues that a glare type or gloss finish presents to people with vision loss.
- Suite – a room or series of rooms of similar use, under a single tenancy, and includes residential dwelling units (houses), motel/hotel rooms, stores, offices, etc.
- TTY (teletypewriter) - a device that allows a user to communicate over a phone line by typing a message. This device was formerly known as a TDD, a Telecommunications Device for the Deaf and hard of hearing. The acronym TTY can also refer to a Text Telephone. A TTY is required at both ends of a conversation. If a TTY is unavailable on the receiving end, Telecommunication Relay Services are also available from telephone service providers. A deaf or hard of hearing person, or person with a speech impediment may use a TTY to type their conversation to a relay agent who then reads the typed conversation to the other party. The relay agent then types the other party's spoken words back to the TTY user.
- Closed captioning – a process of displaying text on a screen or visual display to provide someone who is deaf or hard of hearing with audio content that they would otherwise be unable to access. Closed captioning may also include descriptions of non-speech elements.
- Assistive listening devices – devices that may amplify sound and or transmit audio information. The overall goal is to improve the sound to noise ratio and assist a deaf or hard of hearing person in receiving audio content. Assisted listening devices may include FM systems, Infrared systems, and induction loop systems. Each system has its own strengths and best-case scenarios for application.
- Detectable warning surface – A standardized surface feature built in or applied to walking surfaces or other elements to warn visually impaired people of hazards.
- The Americans with Disabilities Act (ADA). The Americans with Disabilities Act of 1990 (ADA) prohibits discrimination and ensures equal opportunity for persons with disabilities in employment, State and local government services, public accommodations, commercial facilities, and transportation. [www.ada.gov](http://www.ada.gov) provides information and technical assistance on the Americans with Disabilities Act, including the 2010 ADA Standards for Accessibly Design.







*Notes*



*Notes*



The Advisory Committee on Accessibility welcomes questions regarding the content of these Standards and/or project consultations. These can be directed to the following:

**Advisory Committee on Accessibility**

**Administrative Contact**

**Telephone: 3-1-1**

**TTY: 403-268-1379**

**Email: [ACA@calgary.ca](mailto:ACA@calgary.ca)**